



The Friendly **HYBRid EXchange**

GDS-600

Digital Telephone System
ISDN Digital Telephone System

Installation Manual

Notification

Notification is hereby given that Auto Telecom Company Ltd. reserves the right to modify, change, update or revise this document from time to time as required without the prior obligation to notify any person, company or organization. Further, Auto Telecom makes no warranty or representation, either express or implied, with respect to merchantability, or fitness of its products for a particular purpose.

2004 Auto Telecom Company Ltd.

This document or any parts thereof are not to be reproduced or transmitted in any form or by any means, electronic or mechanical, including photocopying, recording, or information storage and retrieval systems for any purpose whatsoever without the express written permission of Auto Telecom Company Ltd. 20-10-2004

IMPORTANT SAFETY INSTRUCTIONS



Installation Safety Precautions:

1. Never install telephone wiring during a lightning storm.
2. Never install telephone jacks in wet locations unless the jack is specifically designed for wet locations.
3. Never touch un-insulated telephone wires or terminals unless the telephone line has been disconnected at the network interface.
4. Use caution when installing or modifying telephone lines.

The **HYBREX** GDS-600 utilizes a 3 pin grounding power supply cord. This cord is not to be attached to any building surfaces. When using your telephone equipment, basic safety precautions should always be followed to reduce the risk of fire, electric shock and injury to persons, including the following:

1. Read and understand all instructions.
2. Follow all warnings and instruction marked on the product.
3. Unplug this product from the wall outlet before cleaning. Do not use liquid cleaners or aerosol cleaners. Use a damp cloth for cleaning.
4. Do not use this product near water, for example, near a bath tub, wash bowl, kitchen sink, or laundry tub, in a wet basement, or near a swimming pool.
5. Do not place this product on an unstable cart, stand, or table. The product may fall, causing serious damage to the product.
6. Slots and openings in the cabinet and the back or bottom are provided for ventilation, to protect it from overheating, these openings must not be blocked or covered. The openings should never be blocked by placing the product on the bed, sofa, rug, or other similar surface. This product should never be placed near or over a radiator or heat register. This product should not be placed in a built-in installation unless proper ventilation is provided.
7. This product should be operated only from the type of power source indicated on the marking label. If you are not sure of the type of power supply to your home or office, consult your dealer or local power company.
8. The socket-outlet shall be installed near the equipment and shall be easily accessible.
9. This product is equipped with a three wire grounding type plug, this plug will only fit into a grounding type power outlet. This is a safety feature. If you are unable to insert the plug into the outlet, contact your electrician to replace your obsolete outlet. Do not defeat the safety purpose of the grounding type plug.
10. Do not allow anything to rest on the power cord. Do not locate this product where the cord will be damaged by persons walking on it.
11. Do not overload wall outlets and extension cords as this can result in the risk of fire or electric shock.
12. Never push objects of any kind into this product through cabinet slots as they may touch dangerous voltage points or short out parts that could result in a risk of fire or electric shock. Never spill liquid of any kind on the product.
13. To reduce the risk of electric shock, do not disassemble this product, but take it to a qualified service man when some service or repair work is required. Opening or removing covers may expose you to dangerous voltages or other risks. Incorrect reassemble can cause electric shock when the appliance is subsequently used.
14. Unplug this product from the wall outlet and refer servicing to qualified service personnel under the following conditions:
 - A. When the power supply cord or plug is damaged or frayed.
 - B. If liquid has been spilled into the product.
 - C. If the product has been exposed to rain or water.
 - D. If the product does not operate normally by following the operating instructions. Adjust only those control, that are covered by the operating instructions because improper adjustment of other controls may result in damage and will often require extensive work by a qualified technician to restore the product to normal operation.
 - E. If the product has been dropped or the cabinet has been damaged.
 - F. If the product exhibits a distinct change in performance.
15. Avoid using a telephone (other than a cordless type) during an electrical storm. There may be a remote risk of electric shock from lightning.
16. Do not use the telephone to report a gas leak in the vicinity of the leak.

SAVE THESE INSTRUCTIONS

HYBREX GDS-600
ISDN Digital Telephone System
General Description - Installation - Programming Manual

Table of Contents

NOTIFICATION	II
GENERAL DESCRIPTION - INTRODUCTION	1
FCC RULES AND REGULATION	1
FCC REGISTRATION NUMBER	1
RINGER EQUIVALENCE NUMBER	1
NOTIFICATION OF THE TELEPHONE COMPANY	1
DIRECT CONNECTION TO A PARTY-LINE OR COIN OPERATED TELEPHONE LINE IS PROHIBITED.	1
INCIDENCE OF HARM TO THE TELEPHONE LINES	1
COMPATIBILITY OF THE TELEPHONE NETWORK AND TERMINAL EQUIPMENT	2
RADIO FREQUENCY INTERFERENCE	2
CTR 21 (98/482/EC) DECLARATION NETWORK COMPATIBILITY	2
ISDN INSTALLATION	2
KEY HIGHLIGHTS OF THE GDS-600 SERIES INCLUDE:	4
ECONOMY AND EFFICIENCY.....	4
EASY INSTALLATION	4
EASY MAINTENANCE.....	4
FLEXIBILITY OF SYSTEM APPLICATIONS	4
VARIED EXTENSION ALTERNATIVES.....	4
FULL ISDN FEATURES.....	5
LIQUID CRYSTAL DISPLAY	5
MECHANICAL SPECIFICATIONS (KEY SERVICE UNIT – SINGLE CABINET).....	7
MECHANICAL SPECIFICATIONS (BATTERY BACK UP HOUSING – 2 REQUIRED).....	7
ENVIRONMENTAL SPECIFICATIONS	7
FEATURES	8
SYSTEM FEATURES	8
STATION FEATURES	9
OPTIONAL FEATURES.....	9
PARTS & PERIPHERALS	10
SYSTEM MODULES.....	10
PERIPHERAL DEVICES	10
OPTIONAL INTERFACE CARDS	10
TYPE OF PHONES	11
SYSTEM INSTALLATION - INTRODUCTION	12
SITE REQUIREMENTS	13
LOCATION.....	13
INSTALLATION CHECKLIST	13
EQUIPMENT REQUIREMENTS	13
INSTALLATION	14

INSTALLING THE EQUIPMENT	14
POWER SUPPLY	14
INSTALLING EXPANSION AND OPTIONAL CARDS.....	15
CARD INTRODUCTION.....	16
INSTALLING CPU AND OPTION CARDS (CONTINUED).....	19
HARDWARE INSTALLATION.....	25
SYSTEM GROUND	46
CONNECTING STATIONS	46
DIGITAL KEY TELEPHONE – DK1-21/22/31/32/33.....	47
DIGITAL KEY TELEPHONE – DK1-21H	48
ACCESS CONTROL TELEPHONE – ACP.....	49
INCORRECT WIRING	50
SINGLE LINE TELEPHONE (CONNECTED TO G2-SLU).....	50
SINGLE LINE TELEPHONE (CONNECTED TO G2-SLU).....	51
DOOR PHONE CONNECTION.....	51
SINGLE LINE TELEPHONE (CONNECTED TO DK-SLD).....	51
CO/PABX CONNECTIONS.....	52
ISDN S/T CONNECTIONS	52
OPTIONAL CABLING	55
DOOR SWITCH (RELAY) CONNECTION	55
SENSOR CONNECTION	55
PAGING CONNECTION.....	55
MUSIC ON HOLD CONNECTION.....	55
RS232 PORT CONNECTION.....	56
POWER ON AND OPERATIONAL TEST	57
OPERATIONAL TESTS.....	57
SPECIAL IMMUNITY PROTECTION FOR SYSTEM AND TERMINALS	57
GDS-600 POWER CONSUMPTION CALCULATION FOR EMERGENCY BATTERY BACKUP	57
GDS-600 POWER CONSUMPTION CALCULATION FOR EMERGENCY BATTERY BACKUP	59
APPENDIX A	61
SOFTWARE UPGRADE	61

General Description - Introduction

The General Description section contains an easy to understand overview of the **HYBEX**[®] GDS-600 ISDN Digital Telephone System. It is the intent of this document to provide both technical and non technical readers with information pertaining to the system building blocks, capabilities, key highlights, electrical, physical and environmental characteristics of the **HYBEX** GDS-600 ISDN Digital Telephone System.

FCC Rules and Regulation

In compliance with the requirements of Part 68 of the Federal Communications Commission Rules and Regulations for connection of terminal system equipment to the telephone network and for your convenience, the following information is presented.

FCC Registration Number

The **HYBEX** GDS-600 is registered with the FCC in a dual registration capacity enabling the system to operate as a key system only or as a hybrid system. The FCC Registration Numbers are [US: 3A7MF03BGDS600](#) for key systems registration and [US: 3A7KF03BGDS600](#) for hybrid operation.

Ringer Equivalence Number

Ringer Equivalence [0.3B](#).

Notification of the Telephone Company

Customers connecting terminal equipment to the telephone network shall, upon request of the Telephone Company, inform the Telephone Company of the particular line(s) to which such connection is made, the FCC registration number and ringer equivalence number (REN) of the registered terminal equipment.

The REN is useful to determine the quantity of devices you may connect to your telephone line and still have all of those devices ring when your telephone number is called. In most, but not all areas, the sum of the REN's of all devices connected to one line should not exceed five (5.0). To be certain of the number of devices you may connect to your line, as determined by the REN, you should contact your local telephone company to determine the maximum REN for your calling area.

This equipment is capable of providing users access to Interstate providers of operator services through the use of access codes. Modification of this equipment by call aggregators to block access dialing codes is a violation of the Telephone Operator Consumers Act of 1990.

Direct Connection to a Party-Line or Coin Operated Telephone Line is Prohibited.

Incidence of Harm to the Telephone Lines

Should terminal equipment cause harm to the Telephone Network, the Telephone Company shall, where practical, notify the customer that service may be temporarily discontinued. However, where prior notice is not practical, the Telephone Company may temporarily discontinue service, if such action is reasonable in the circumstances. In case of such un-notified temporary discontinuance of service, the Telephone Company shall:

- (a) Promptly notify the customer of such temporary discontinuance of service.
- (b) Afford the customer the opportunity to correct the situation which gave rise to the temporary discontinuance.
- (c) Inform the customer of the right to bring a complaint to the FCC pursuant to the procedures set out in Subpart E of Part 68 of FCC Telephone Equipment Rules.

Compatibility of the Telephone Network and Terminal Equipment.	
(a)	Availability of telephone interface information.
	Technical information concerning interface parameters and specifications not specified in FCC Rules, including the number of Ringers which may be connected to a particular line, which is needed to permit Terminal Equipment to operate in a manner compatible with Telephone Company communications facilities, shall be provided by the Telephone Company upon customer's request.
(b)	Changes in Telephone Company Communications Facilities, Equipment, Operations and Procedures.
The Telephone Company may make changes in its communications facilities, equipment, operations or procedures where such action is reasonably required in the operation of its business and is not inconsistent with the rules and regulations in FCC Part 68 of the FCC Rules and Regulations. If such changes can be reasonably expected to render any customer Terminal Equipment incompatible with Telephone Company Communications Facilities, or require modification or alteration of such Terminal Equipment, or otherwise materially affect its use or performance, the customer shall be given adequate notice in writing to allow the customer an opportunity to maintain uninterrupted service.	

Radio Frequency Interference	
This equipment generates and uses radio frequency energy and if not installed and used properly and in strict accordance with the manufacturer's instructions, may cause interference to radio and television reception. It has been type-tested and found to comply with the limits for a Class A computing device in accordance with the specification in Subpart J of Part 15 of FCC Rules, which are designed to provide reasonable protection against such interference in a residential installation. However, this is no guarantee that interference will not occur in a particular installation. If this equipment does cause interference to radio or television reception, which can be determined by turning the equipment off and on, the user is encouraged to try to correct the interference by one or more of the following measures:	
	<ul style="list-style-type: none"> Re-orient the receiving antenna. Relocate the equipment with respect to the receiver. Move the equipment away from the receiver. Plug the equipment into a different outlet so that equipment and receiver are on different branch circuits.

CTR 21 (98/482/EC) Declaration Network Compatibility

CTR 21 (98/482/EC) Declaration Network Compatibility, 'The equipment has been approved in accordance with Council Decision 98/482/EC for pan-European single terminal connection to the public switched telephone network (PSTN). However, due to differences between the individual PSTNs provided in different countries, the approval does not, of itself, give an unconditional assurance of successful operation on every PSTN network termination point. In the event of problem, you should contact your equipment supplier in the first instance.'

ISDN Installation

For the ISDN unit (G2-SIU), GDS-600 only offers ISDN S/T interface connection behind an NT1 device. It can not be connected to a "U" interface directly.

Description

The GDS-600 is an advanced ISDN Digital hybrid telephone system employing a microprocessor stored program and digitally controlled solid state Time-division switching. The GDS-600 system is specifically designed for small business as well as residential applications. At the forefront of the system design is a universal concept to adapting and connecting with a variety of communications devices. Productive **HYBREX** Digital Key Telephones offer thoughtfully designed productive feature access to keep you connected with one another and customers. Auto Telecom technology leads the industry in providing for compatibility with devices such as fax machines, answering machines, cordless phones, computer modems and other office/home equipment.

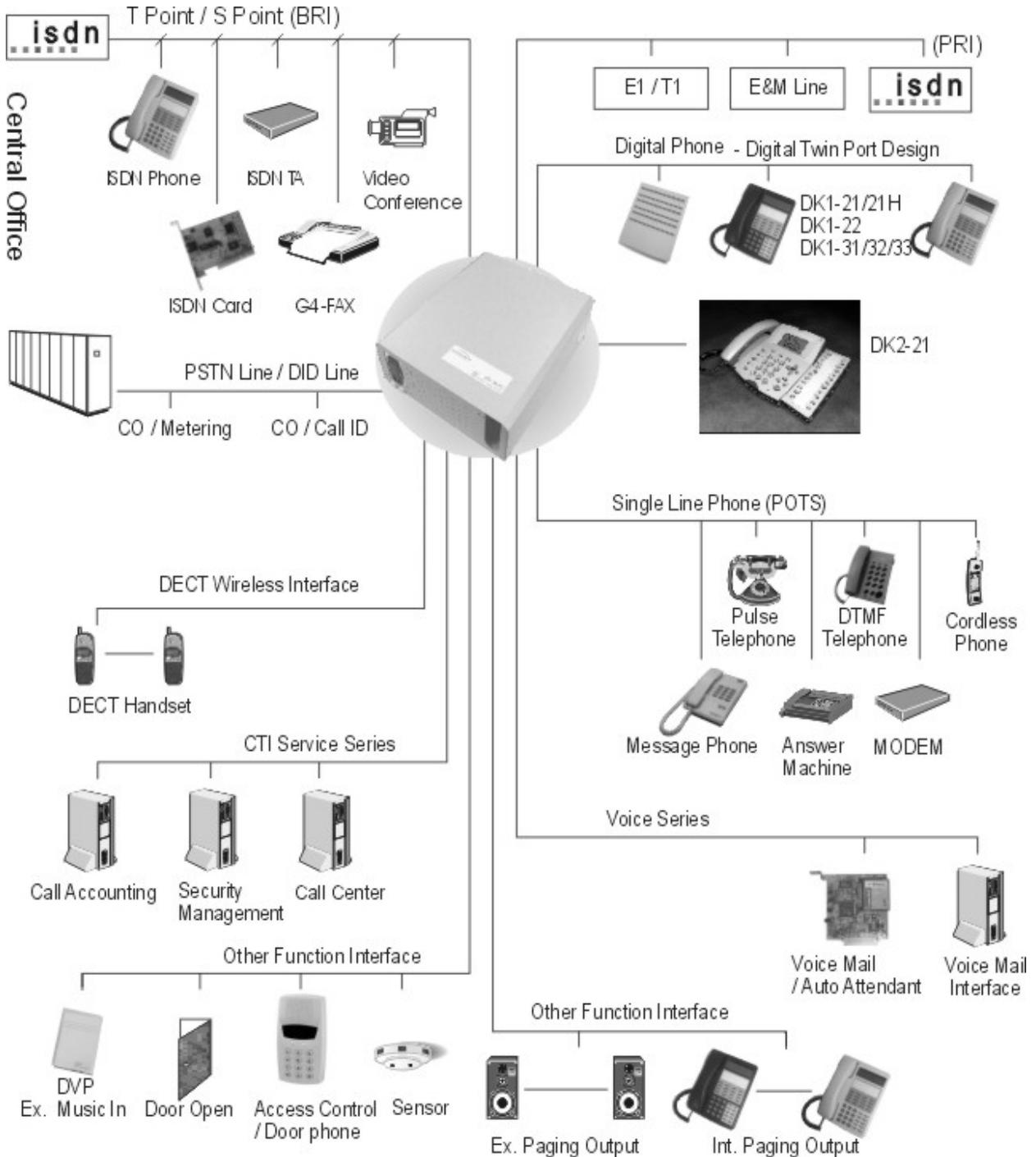

Key highlights of the GDS-600 series include:

Economy and Efficiency

The base system is equipped to support four (4) CO lines / two (2) or three (3) ISDN BRA's and eight (8) digital stations. The system may be expanded to a maximum of Twenty (20) CO lines in the 80 port and Sixteen (16) in the 64 port cabinet / six (6) ISDN BRA's or Thirty ISDN PRI Channels. Station cards may be selected to allow practically any combination ranging from all **HYBREX** DK1 Digital Sets to all industry standard Single Line Telephone sets, with a combination of the two types. This makes the system cost effective at the initial phase and when expanded to its maximum capacity. This allows a wide variety of applications for the system to work effectively.

Easy Installation

- "Factory Ready" - All GDS-600 Telephone systems are "ready to go" right out of the box. A well thought out default database is factory installed on each system which meets the needs for most installations. This alleviates hours of on site time, minimizing installation costs for both dealer and customer.
- "Small & Compact" - The Key Service Unit's small size takes little space for installation.

Easy Maintenance

- Solid-state design minimizes trouble and eliminates periodic maintenance.
- Easy Expansion. Various plug in Interface Cards for simple, modular expansion.
- Versatile programming and options for ease of setup.
- Database Flash Memory Back Up - Customer data is backed up when the power is turned off and there is no battery to replace.
- Battery Back Up (System Operation) - GDS-600 systems can be equipped with an optional battery back up which keeps the system operational for a minimum **1 hour** in the case of a commercial power failure.
- Customer Care Programming - Customers and service personnel can easily communicate and perform programming right over the telephone. **HYBREX** telephone systems allow programming and voice conversations to be performed at the same time.
- Advanced software upgrades – Through the RS232 / LAN / Internet(TCP/IP) connection, system software can be upgraded easily without replacing any firmware.

Flexibility of System Applications

Unlike other conventional systems in the GDS-600 size range, the installer will find an unprecedented range of customer database programmability. In "system parameters" there are extensive options for various timing settings related to features. An array of parameters are programmable for signaling options on outside lines and internal single line telephone sets. The installer may Enable/Disable many system wide features. And in class of service, there are over 30 options for each station providing maximum flexibility for nearly any application.

Varied Extension Alternatives

You can connect an ISDN Modem, ISDN phone, proprietary **HYBREX** DK series KeyPhone, [Access Control Phone \(ACP\)](#), Door Phone and conventional industry standard single line sets – Modem, Answering Machine, Cordless phone, etc. directly to the KSU. This feature provides you with the choice to select different extension equipment to suit individual applications.

Full ISDN features

The GDS 600 system allows you to access different outside line types (PSTN & ISDN BRI, PRI, T1, E1, ...) in one box and enjoy **Full ISDN Features when accessing an ISDN Line** - such as:

- . Call Charge Metering Information
- . Caller Identification
- . Direct Inward Dialing
- . Call Forward Internal / External
- . Call Waiting
- . MSN (Multiple Subscriber Number)
- . Sub-addressing
- . User to User Signaling

You can easily control your budget by using different outside line arrangements.

Liquid Crystal Display

The DK1 Series Telephone Model DK1-21 / DK1-31 is equipped with a large, easy to read LCD display. The LCD is 32 characters total, comprised of 2 rows by 16 characters each.

The DK2 Series Telephone Model DK2-21 is equipped with a large, easy to read LCD display. The LCD is 64 characters total, comprised of 4 rows by 16 characters each.

This LCD provides an invaluable tool for simplifying the use of the telephone by identifying the calling extension by name, outside lines by name and self prompting displays for feature access. Station feature usage is made simple with the help of the LCD display. Continuous prompting information is displayed during calls so that users know what to do and when to do it.

32-character LCD Display shows:

- Time
- Dialed telephone number
- Voice Mail Messages
- CO Line Names
- Last Number Redial
- Speed dial number
- Last number dialed
- The status of operation/function
- Absent messages
- Speed Dial Directory
- Calling Party Number and Name
- Input data during system data entry

HYBREX Telephone Models



DK1-21/DK1-31



DK1-22



ACP



DK-SLD



DK2-21

MAXIMUM LOOP RESISTANCE/IMPEDANCE	
Key Telephone	26 AWG / 200 m 24 AWG / 300 m
Single Line telephone	26 AWG / 1000 m 22 AWG / 3000 m
Doorphone	Less than 40 ohms
Music Source Input Impedance	600 ohms
Maximum Input	0.775 VRMS
INTERNAL RELAY CONTACTS	
Type	SPST
Rating	1 AMP, 24VDC
Function	Door Switch, Music on Hold, etc
CABLE REQUIREMENTS	
CO/PABX Line	Twisted 1 Pair (2 wires)
ISDN BRI	Twisted 2 Pair (4 wires)
ISDN PRI	Twisted 2 Pair (4 wires)
DK1/- Telephone	Twisted 1 Pair (2 wires)
Doorphone	Twisted 1 Pair (2 wires)
Door Switch	Twisted 1 Pair (2 wires)
External Sensor	Twisted 1 Pair (2 wires)
External Music Source	Twisted 1 Pair (2 wires)
Single Line Telephone	Twisted 1 Pair (2 wires)

Mechanical Specifications (Key Service Unit – single cabinet)

CABINET DIMENSIONS		
357 mm W	126 mm D	436 mm H
14.1"	4.96"	17.2"
WEIGHT		17 Kg (Configuration: 4 x 8)
		37.4 lbs

Mechanical Specifications (Battery Back Up Housing – 2 required per cabinet)

CABINET DIMENSIONS		
15.5" W	3.0" D	5.75" H
WEIGHT		With Batteries -16 lbs Without Batteries- 4 lbs.
Mounting Screws	12.25" center to center	

Environmental Specifications

	OPERATING CONDITIONS	STORAGE CONDITIONS
Temperature	0° to 45° C (32° to 113° F)	-40° to 66° C (-40° to 150° F)
Humidity	10 to 95% relative Non-condensing	10 to 95% relative non-condensing

Features

System Features

Account Code Capability
Attendant Console Assignment
Attendant Overflow
Automatic Line Access
Automatic Line Search
Automatic Ringdown
Automatic Wake-up
Battery Charger
Behind PABX Operation
Centrex Operation
Class Of Service
CO Line Groups
CO Line Hunting
CO Line Name Programming
CO Line Ring Types
 Linear
 Common Audible
 Circular
 Hunt
Console Assignment
Day/Night Service
 Manual/Automatic Switch
Dial 9 Group
Direct In Line
Dial By Name
Dial Mode Selection(DP/DTMF)
Dial Pulse to DTMF Conversion
Distinctive Ringing
DTMF Signaling
Dual Port Capability
End to End Signaling
Easy Installation and Operation
Flash (Programmable)
Flash Memory Backup Memory
Flexible Expansion
Flexible Ringing Assignment
Flexible Key Group Assignment
Flexible Number Plan 2,3 or 4 Digit
Flexible Time Format 12/24 Hour
Forced Account Code Assignment
Intercom
Intercom Single Digit Assignment
Intercom Ring / Voice Select
Intercom Dialing Restriction

ISDN

Call Charge Metering Information
Caller Identification
Direct Inward Dialing
Call Forward Internal / External
Call Waiting
MSN (Multiple Subscriber Number)
Sub-addressing
User to User Signaling
Host PABX Access
Hot line
Line Group Assignment
Loud Bell Assignment
Multiple Attendant Consoles
Multiple Trunk Groups
Night Transfer
On Call Programming
Paging
 Internal
 Zone
 Meet Me
Password Assignment
 DISA
 System programming
 Toll Override
Pause
Pick Up Groups
Power Fail Transfer
Security Code
Single Digit Dialing
Station Group Assignment
Station Hunting
Station Lock
System Speed Dial and Personal Speed Dial
System Date & Time Setting
System Time-Reminder Service
Telephone Directory
Toll Control
 Day / Night
Tone to pulse dialing
Trunk Queuing
Trunk to trunk connections
Uniform Call Distribution
Voice Mail Compatibility

Station Features

Advisory Messages
 System
 Personal
 Access to System Programming
 Account Code Capability
 Auto Hold
 Auto Hold Recall
 Automatic Call Back
 Automatic Answer-Intercom
 Automatic Line Access
 Automatic Redial
 Automatic Volume Increase
 Brokers Call
 Call Duration Timer (LCD Phones)
 Call Waiting
 Call Forwarding
 All Calls
 Busy
 No Answer
 Busy / No Answer
 External
 Call Pickup
 Call Split
 Call Transfer
 Calling Name Display (LCD Phones)
 Calling Number Display (LCD Phones)
 Camp On
 Chain Dialing
 Conference
 Dial By Name (LCD Phones)
 Dial Access to Attendant
 Direct Station Selection
 Door phone Access
 Do Not Disturb (DND)
 Dual Color LED
 Duration Time Display (LCD Phones)
 Executive Override (Barge-In)
 External Call Forwarding
 Flash (Open Loop Timed Flash)
 Hands-free Answer Back
 Hearing Aid Compatibility
 Headset Compatibility
 Hold (Exclusive / System)
 Hold Recall
 I Hold Indication
 I Use Indication
 Intercom
 Intercom ring / voice interchange
 Intercom Step Call
 Intercom Voice Announce
 Last Number Redial
 Message Waiting
 Multi-Language Display

On Hook Dialing
 Prime Line Select
 Privacy
 Privacy Release
 Private Line
 Pulse/Tone Conversion
 Ring Frequency Selection
 Ringing Line Preference
 Saved Number Redial
 Speed Dialing
 Station Lock / Unlock
 Station Monitor
 Store Speed Dial/DSS Number
 Timed Reminder Service
 System
 Station
 Toll Restriction Override
 Trunk Queuing
 Volume Control
 Handset
 Speaker
 Ringer

Optional Features

Access Control Phone
 Automated Attendant
 Battery Backup (System)
 Direct Inward System Access (DISA)
 Door phone / Door Latch
 Dual Port Operation
 External Music Source

 Music On Hold
 Relay Control
 RS232
 Security Sensor/Door Open Indication
 Station Message Detail Record (SMDR)
 Voice Mail

Parts & Peripherals

System Modules

<i>Model</i>	<i>Description</i>
G2-MMD160	Master Device 80 port Cabinet for 160 ports including: 80 port cabinet x 1, MBU, PWU, MPU2, IPU, MSU, IXU
G2-MMD320	Master Device 80 port Cabinet for 320 ports including: 80 port cabinet x 1, MBU, PWU, MPU4, MXU4, IPU, MSU, IXU
G2-MMD640	Master Device 80 port Cabinet for 640 ports including: 80 port cabinet x 1, MBU, PWU, MPU8, MXU8, IPU, MSU, IXU
G2-EMD80	Expansion modular device - 80 ports including: 80 port cabinet x 1, MBU, PWU, IPU, IXU
G2-MPU2	G2 128/144/160 Main CPU Controller
G2-MPU4	G2 320 Main CPU Controller
G2-MXU4	G2 320 Multiple Exchange Unit
G2-MPU8	G2 640 Main CPU Controller
G2-MXU8	G2 640 Multiple Exchange Unit
G2-IXU	Interface Auxiliary Unit – Expansion PCM streams for G2-EMD80
G2-IPU2	G2-1648 Main CPU Controller / G2 128 / 144 / 160 / 320 / 640 Interface Control Card.
G2-MSU	Multi-Service Card (External Paging/ Relay/ Sensor / RS232/ MODEM Interface/ Door Phone / External MOH Interface)
G2-TKU	Trunk Card : 4 CO lines
G2-TKU2	Trunk Card : 8 CO lines
G2-PIU	ISDN PRI Interface: 23/30 Channels Maximum
G2-PIU/T1	T1 Interface: 23 Channels Maximum
G2-PIU/E1	E1 Interface: 30 Channels Maximum
G2-SIU-3	ISDN S/T interface with 3 circuits
G2-VIU	VOIP Trunk card: 3 Channels
G2-STU	Station Card : 4 Digital Twin-ports
G2-STU2	Station Card : 8 individual Digital ports – Hot swap.
G2-SLU	Single Line Card : 8 SLT ports, DC 90V and CLIP function
G2-SLU2	Single Line Card : 8 SLT ports, DC 90V and CLIP function – Hot Swap
G2-HSU 44	4 Port Digital plus 4 port Analogue card.
G2-PWU	G2 Power Supply

Peripheral Devices

<i>Model</i>	<i>Description</i>
DPU05	Door Phone - 2 Wires
BBOX0	Battery Box without Batteries
BBOX1	Battery Box with Batteries

Optional Interface Cards

<i>Model</i>	<i>Description</i>
G2-VMU	Voice Mail Unit (4 Channels) / Auto Attendant / Wake-up / Message Waiting
G2-CIC	Caller ID Card for G2-TKU – Dual Mode (FSK/DTMF)
G2-CIC-F	Caller ID Card for G2-TKU – FSK Mode
G1-MDC	4 Channel Metering Card for G2-TKU - 12/16Khz

Type of Phones

<i>Model</i>	<i>Description</i>
DK2-21	Multifunction Key Telephone. Includes 64 character LCD display, speakerphone, handsfree, headset jack, 22 dual color keys and 17 function keys for feature access, DSS, CO Lines and speed dial.
DK2-21W	Multifunction Key Telephone. Includes 64 character LCD display, speakerphone, handsfree, wireless headset jack, 22 dual color keys and 17 function keys for feature access, DSS, CO Lines and speed dial.
DK1-21	Multifunction Key Telephone. Includes 32 character LCD display, speakerphone, handsfree, headset jack, 20 dual color keys and 14 function keys for feature access, DSS, CO Lines and speed dial.
DK3-21	Multifunction Key Telephone. Includes 32 character LCD display, speakerphone, 10 dual color keys and 14 function keys for feature access, DSS, CO Lines and speed dial.
DK3-31	Multifunction Key Telephone. Includes 32 character LCD display, speakerphone, headset jack, 10 dual color keys and 17 function keys for feature access, DSS, CO Lines and speed dial.
DK3-33	Multifunction Key Telephone. Includes speakerphone, headset jack, 10 dual color keys and 17 function keys for feature access, DSS, CO Lines and speed dial.
DK-SLD	Two Port SLT device – Convert a Digital port to two POTS ports
ACP	Access Control Phone
ACP/RF	Access Control Phone with RF Proximity Card function
PX-Card	RF Proximity Card for ACP/RF
WMU-12	Wall Mount Kit for DK1 Series Telephones

System Installation - Introduction

This section provides directions for installing the system and optional equipment. The installation must be performed by qualified service personnel.

Main components of the system are:

Key Service Unit, which includes:

- Power Supply Unit (G2-PWU)
- Main KSU (G2-MMD-m/G2-MMD/G2-EMD)
- CPU Unit (G2-MPU/G2-IPU)
- Multi-Service Unit (G2-MSU)
- Interface Auxiliary Unit (G2-IXU)

Optional Expansion Cards:

- Trunk Card (G2-TKU/TKU-2/ G2-SIU / G2-PIU)
- Digital Station Card (G2-STU – four digital twin port circuits / G2-STU2 8 Digital ports)
- Single Line Station Card (G2-SLU – eight single line port circuits G2-SLU2 – eight single line ports)
- G2-CIC Card (Caller ID Card - four port circuits)
- Voice Mail Unit (G2-VMU)
- Metering Card (G1-MDC)

NOTE: Please follow the directions step by step. The GDS-600 system should be installed in strict accordance with this manual.

Site Requirements

Location

Choosing the Right Environment

- System should be installed in a clean, dry, secure location. This location must have adequate ventilation, and a temperature from 0 to 45 (32 to 113), with 10% to 95% non-condensing relative humidity. DO NOT install the equipment near sources of static electricity, excessive vibration, or water. Avoid direct sunlight.

Installation Checklist

INSTALLATION REQUIREMENTS	VERIFICATION
MOUNTING SURFACE	Flat surface with adequate space for main cabinet, power supply, wiring and optional Battery Backup cabinet.
AC LINE	AC line should be dedicated exclusively to the system.
POWER OUTLET	Power Outlet must be a 3-wire grounded outlet plug. Input power Line capacity requirements - 10 amperes.
SURGE PROTECTION	A Surge Protector is recommended on the dedicated AC line.
VENTILATION AND TEMPERATURE	Humidity: 10% to 95% relative non-condensing Temperature: 32 to 113 (0 to 45).
EARTH GROUND	A proper ground connection. (14 AWG)
SERVICEABILITY	Lighting conditions and working space adequate for future service.

Equipment Requirements

- Unpack, Check and Verify Equipment - Unpack the telephone equipment boxes and verify the contents in accordance with the packing list provided. If any discrepancies are noticed, please contact Auto Telecom or Authorized Dealers.
- Damaged Boxes - If you notice any damage to the packages, please notify both the shipper and Auto Telecom or Authorized Dealers at once.
- List of parts included in basic KSU box:
 - KSU Main Cabinet
 - Power Supply
 - Mounting Template
 - Mounting Screws
 - Station Quick Connectors
 - Spare Fuses
 - Cable Cover

Installation

Caution

1. This system should be installed by qualified service personnel.
2. Do not install the Power Supply unless you have read the following instructions and completed all the installation and wiring.
3. **STATIC SENSITIVE DEVICES!** Please handle with care.

Installing the Equipment

Backboard

Be sure to plan and allow enough space to mount and connect the key service unit, power supply and system battery back up if applicable.

Key Service Unit

Use the enclosed Hanging Template to locate the mounting position for the Key Service Unit. Drill appropriately spaced holes to fix the Hanging Template and mount the KSU on the wall. When mounting the KSU, make certain that there is adequate room for the future system expansion and that the connecting power cable between the power mains and the KSU. The same applies for the battery back up unit.

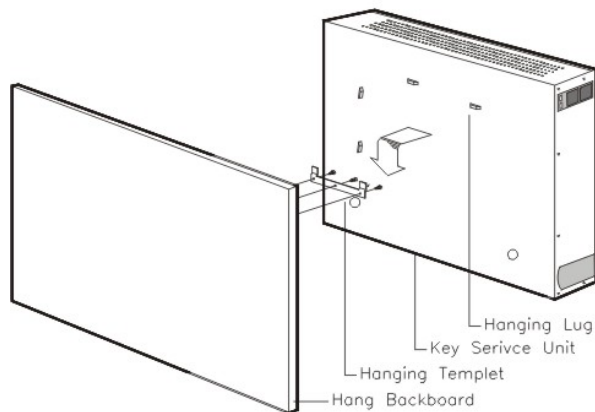

Power Supply

Dedicated Power Source - The power supply must be connected to a dedicated AC outlet.

Be sure that the third wire earth ground of the AC circuit is connected to a good electrical ground. If a music source is installed, it must be connected to a separate AC circuit rather than the system's dedicated AC line cord.

Check Your Voltage Selection Jumper

Verify that the input voltage and input voltage jumper are correct before you power on the system. The input voltage is set according to the Customer's requirement before shipping. However it is important to verify that the setting is correct prior to initial system power up.

Power Supply voltage options for the unit:

100-VAC: 100 to 120 V AC (50/60Hz) or 240-VAC: 205 to 265 V AC (50/60Hz).

Installing expansion and optional cards

In this step you will be installing printed circuit cards on to slots of the main board in the basic cabinet. Take your time and extra care to assure the printed circuit cards are properly aligned. After installing each option and expansion card, perform a visual inspection to assure the printed circuit card is installed properly.

1. Remove the 4 screws located at the corners of the cabinet and lift the front cover off.
2. Install the specific cards into the dedicated slots of G2-MBU as below card introduction.

Card Introduction

G2-MBU – 40 ports

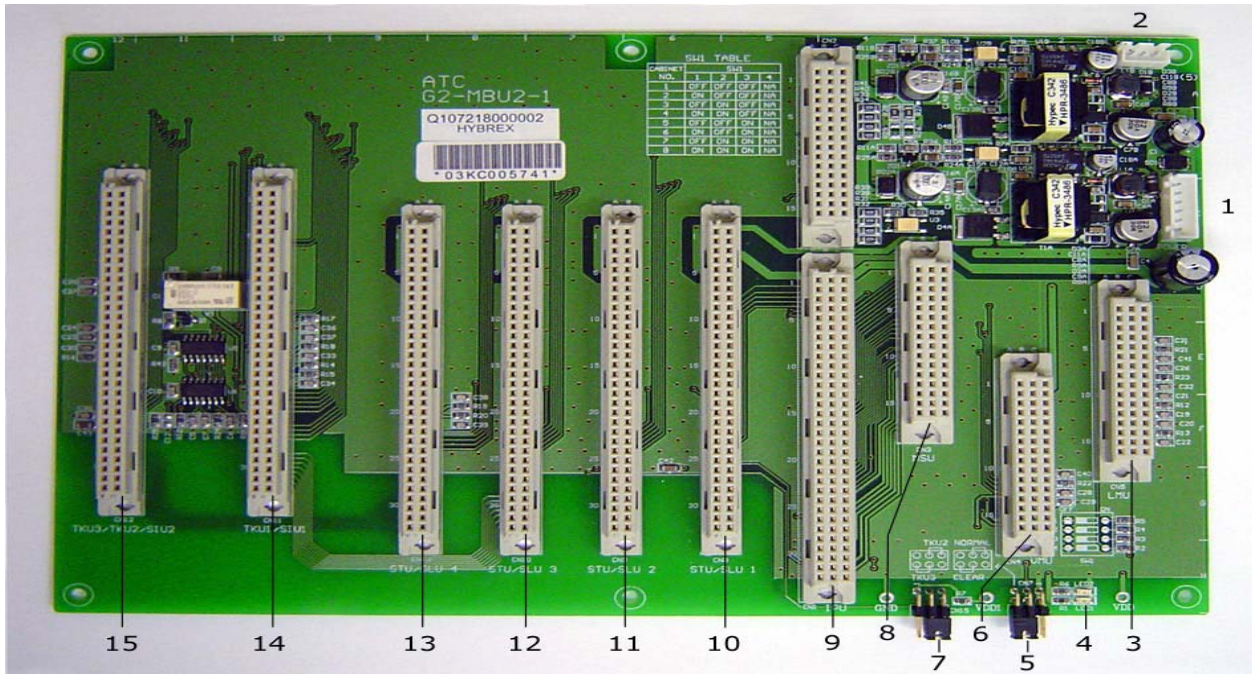

- 1.) Power socket to connect to the main power unit (G2-PWU)
- 2.) Fan power input (3-PIN)
- 3.) G2-MPU2/G2-MPU4/G2-MPU8 slot
- 4.) LED1: Power LED of system (Steady on when power is ON)
- 5.) JP1: Reset jumper for flash memory
- 6.) VMU slot
- 7.) TKU Slot 2/3 setting Jumper
- 8.) MSU slot
- 9.) G2-IPU2 slot
- 10.) STU/SLU 1 slot
- 11.) STU/SLU 2 slot
- 12.) STU/SLU 3 slot
- 13.) STU/SLU 4 slot
- 14.) TKU 1 slot
- 15.) TKU 2 slot

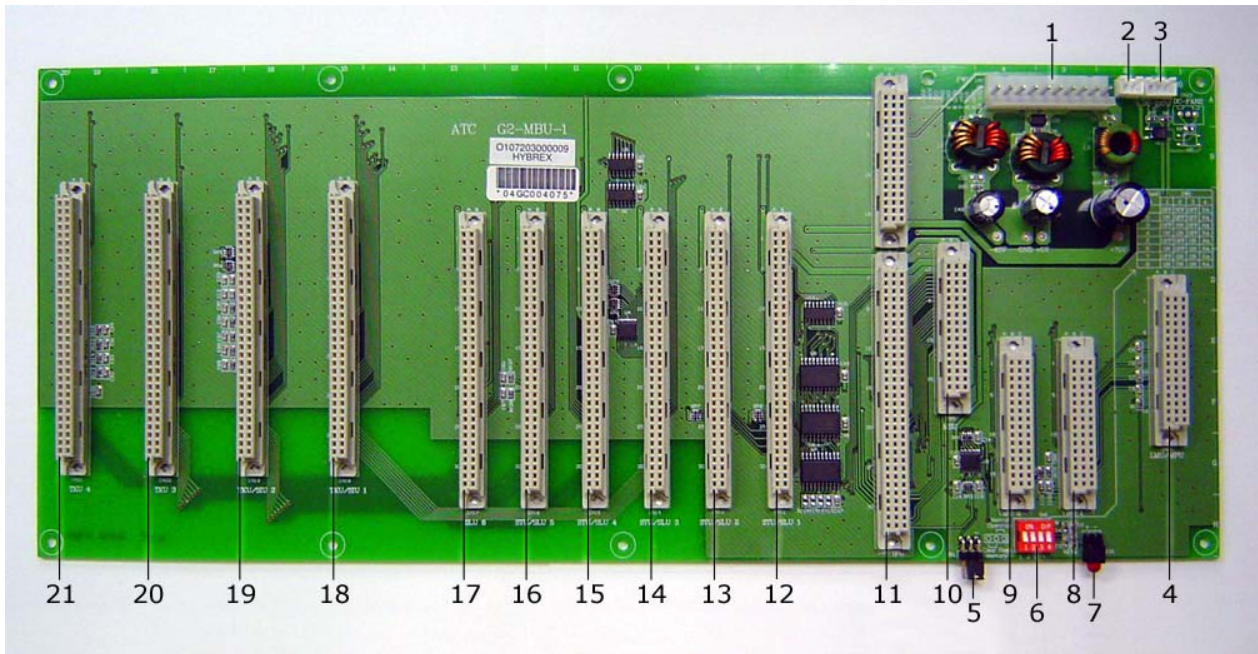
G2-MBU (64 Ports)

- 1.) CN1: Power socket to connect to the main power unit (G2-PWU)
- 2.) Fan Input power
- 3.) Fan power output
- 4.) MPU slot
- 5.) Reset jumper for flash memory
- 6.) Cabinet position selection
- 7.) Power LED Solid red when power on
- 8.) VMU 1 slot
- 9.) VMU 2 slot
- 10.) MSU slot
- 11.) G2-IPU2 Slot
- 12.) STU/SLU 1 slot
- 13.) STU/SLU 2 slot
- 14.) STU/SLU 3 slot
- 15.) STU/SLU 4 slot
- 16.) STU/SLU 5 slot
- 17.) SLU slot 6
- 18.) TKU/SIU/PIU 1 slot
- 19.) TKU/SIU 2 slot
- 20.) TKU3 slot
- 21.) TKU4 slot

Power Failure Transfer – Port Mapping

TKU	CN18	CN19	CN20	CN21
SLU (the first 4 ports)	CN14	CN15	CN16	CN17

G2-MBU – 80 Ports

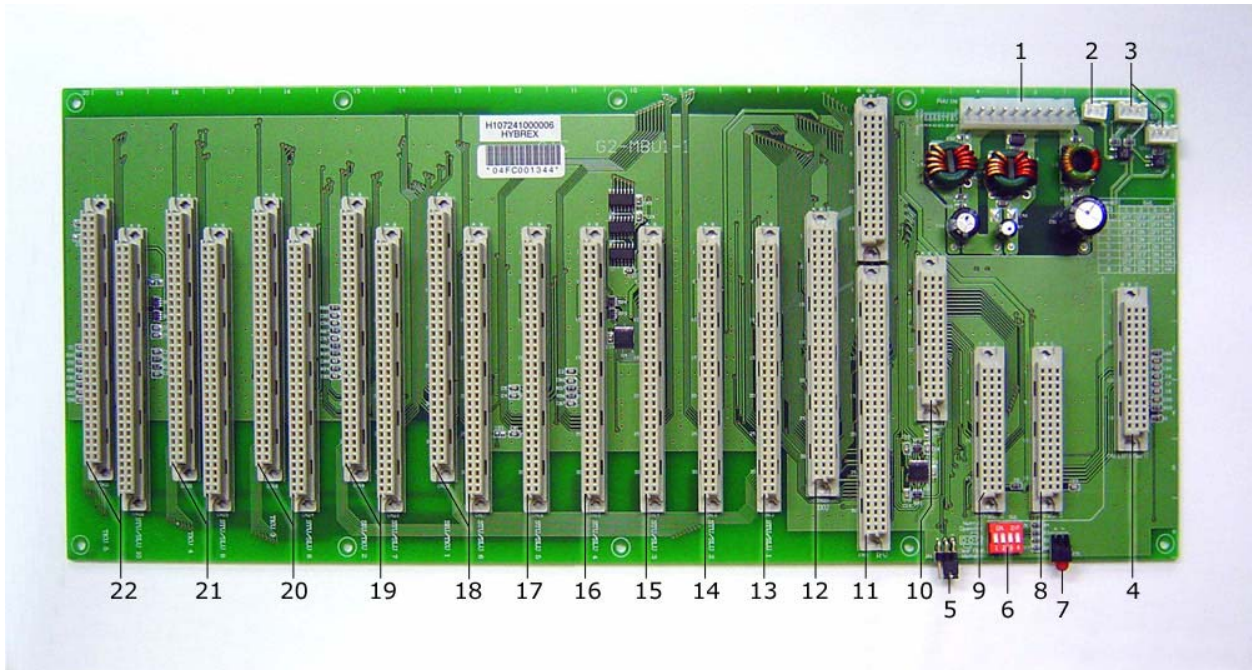

- 1.) Power socket to connect to the main power unit (G2-PWU)
- 2.) Fan Power Input
- 3.) Fan power output x 2 (3 Pin)
- 4.) MPU slot
- 5.) JP1: Reset jumper for flash memory
- 6.) SW1: Cabinet position selection
- 7.) LED 1 Power LED of system. (Steady on when power is on)
- 8.) CN3: VMU 1 slot
- 9.) CN4: VMU 2 slot
- 10.) CN5: MSU slot
- 11.) CN6: G2-IPU slot
- 12.) IXU Slot
- 13.) CN12: STU/SLU 1 slot
- 14.) CN13: STU/SLU 2 slot
- 15.) CN14: STU/SLU 3 slot
- 16.) CN15: STU/SLU 4 slot
- 17.) CN16: STU/SLU 5 slot
- 18.) CN17: TKU/SIU/PIU 1 slot /STU/SLU 6 Slot
- 19.) CN18: TKU/SIU 2 slot /STU/SLU 7 Slot
- 20.) CN19: TKU 3 slot /STU/SLU 8 Slot
- 21.) CN20: TKU 4 slot /STU/SLU 9 Slot
- 22.) CN21: TKU 5 slot /STU/SLU 10 Slot

Installing CPU and option cards (continued)

G2-MPU2

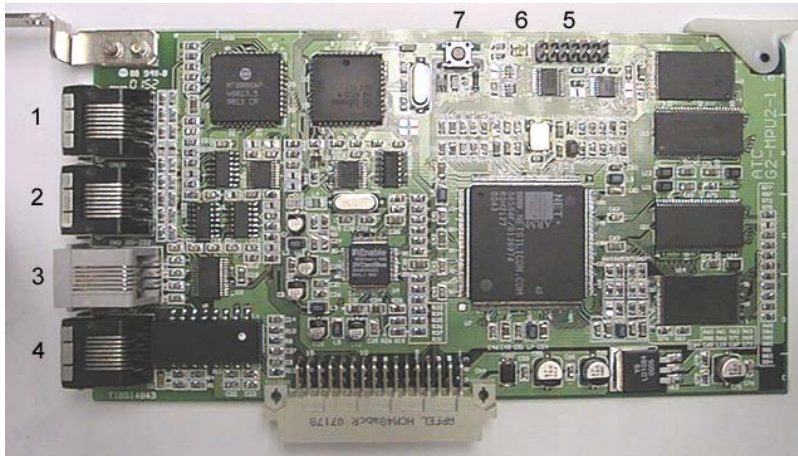

1. Expansion connector 1 for G2-IPU2 in the first cabinet
2. Expansion connector 2 for G2-IPU2 in the second cabinet
3. RS232 port
4. TCP/IP LAN port
5. Factory Test connector
6. LED: Heart Bead
 - A. Flash green slow: MPU2 is working normally
 - B. Flash red slow: Software of G2-MPU2 is upgrading from TCP/IP LAN connection
 - C. Flash green/red slow: G2-MPU2 is sync. with IPU2s
 - D. Flash green/red fast: G2-MPU2 is upgrading the main software into the Flash Memory. System is prohibited to be turned off at this stage. Otherwise system cannot boot.
7. Reset button

Note:

The minimum level of G2-MBU to work with G2-MPU2 is G2-MBU-1(8).
 The minimum level of G2-IPU2 to work with G2-MPU2 is G2-IPU-1(6) or G2-IPU2.

G2-MPU4

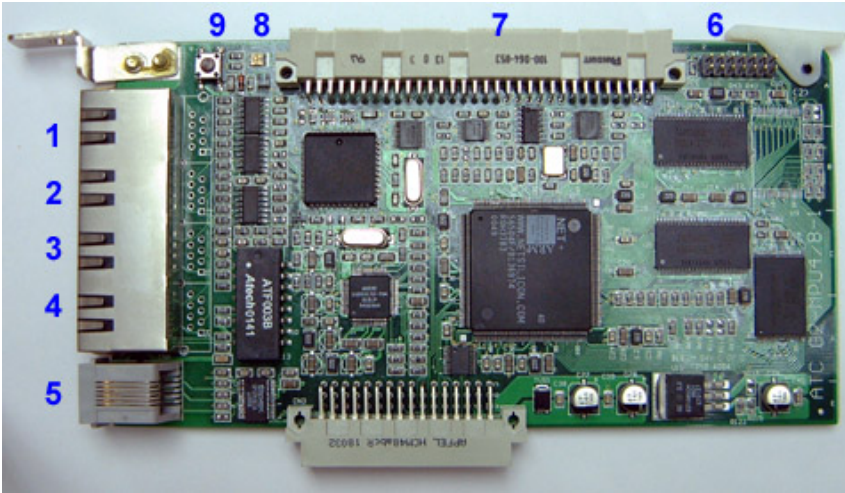

1. TCP/IP LAN port
2. Expansion connector 1 for G2-IPU2 in the 2nd cabinet
3. Expansion connector 2 for G2-IPU2 in the 3rd cabinet
4. Expansion connector 3 for G2-IPU2 in the 4th cabinet
5. RS232 port
6. Factory Test connector
7. Connector for the flat cable to G2-MXU4
8. LED: Heart Bead
 - A. Flash green slow: MPU4 is working normally
 - B. Flash red slow: Software of G2-MPU4 is upgrading from TCP/IP LAN connection
 - C. Flash green/red slow: G2-MPU4 is sync. with IPU2s
 - D. Flash green/red fast: G2-MPU4 is upgrading the main software into the Flash Memory. System is prohibited to be turned off at this stage. Otherwise system cannot boot.
9. Reset button

Note:

The minimum level of G2-MBU to work with G2-MPU2 is G2-MBU-1(8).

The minimum level of G2-IPU2 to work with G2-MPU2 is G2-IPU-1(6) or G2-IPU2.

G2-MXU4

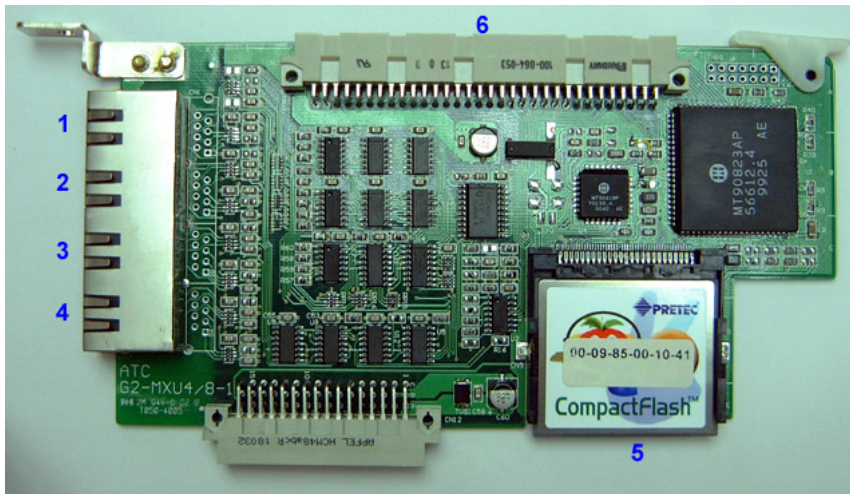

1. Expansion connector 1 for G2-IXU in the 1st cabinet
2. Expansion connector 2 for G2-IXU in the 2nd cabinet
3. Expansion connector 3 for G2-IXU in the 3rd cabinet
4. Expansion connector 4 for G2-IXU in the 4th cabinet
5. CF card for programming data
6. Connector for the flat cable to G2-MPU4

G2-MPU8

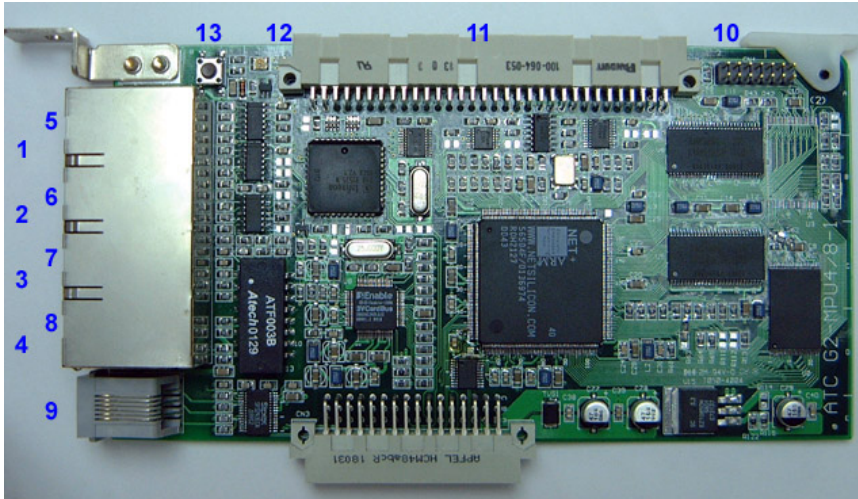

1. TCP/IP LAN port
2. Expansion connector 1 for G2-IPU2 in the 2nd cabinet
3. Expansion connector 2 for G2-IPU2 in the 3rd cabinet
4. Expansion connector 3 for G2-IPU2 in the 4th cabinet
5. Expansion connector 4 for G2-IPU2 in the 5th cabinet
6. Expansion connector 5 for G2-IPU2 in the 6th cabinet
7. Expansion connector 6 for G2-IPU2 in the 7th cabinet
8. Expansion connector 7 for G2-IPU2 in the 8th cabinet
9. RS232 port
10. Factory Test connector
11. Connector for the flat cable to G2-MXU8
12. LED: Heart Bead
 - A. Flash green slow: MPU4 is working normally
 - B. Flash red slow: Software of G2-MPU4 is upgrading from TCP/IP LAN connection
 - C. Flash green/red slow: G2-MPU4 is sync. with IPU2s
 - D. Flash green/red fast: G2-MPU4 is upgrading the main software into the Flash Memory. System is prohibited to be turned off at this stage. Otherwise system cannot boot.
13. Reset button

Note:

The minimum level of G2-MBU to work with G2-MPU2 is G2-MBU-1(8).

The minimum level of G2-IPU2 to work with G2-MPU2 is G2-IPU-1(6) or G2-IPU2.

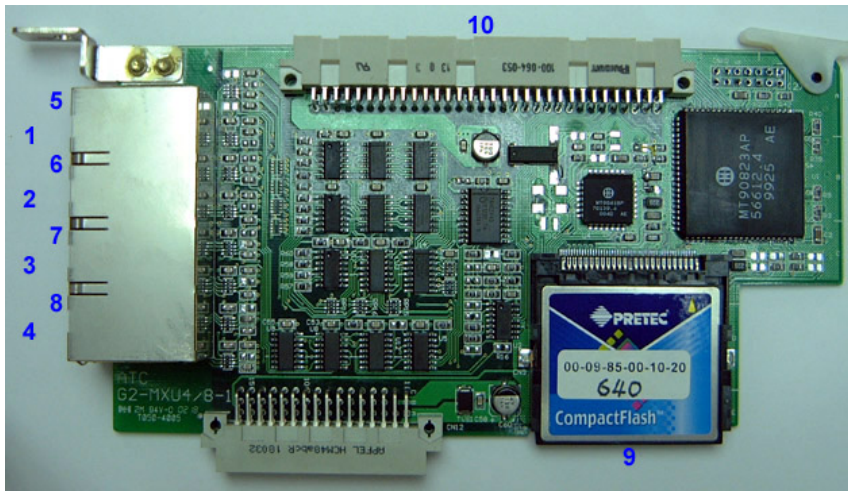
G2-MXU8

1. Expansion connector 1 for G2-IXU in the 1st cabinet
2. Expansion connector 2 for G2-IXU in the 2nd cabinet
3. Expansion connector 3 for G2-IXU in the 3rd cabinet
4. Expansion connector 4 for G2-IXU in the 4th cabinet
5. Expansion connector 5 for G2-IXU in the 5th cabinet
6. Expansion connector 6 for G2-IXU in the 6th cabinet
7. Expansion connector 7 for G2-IXU in the 7th cabinet
8. Expansion connector 8 for G2-IXU in the 8th cabinet
9. CF card for programming data
10. Connector for the flat cable to G2-MPU8

G2-IPU2

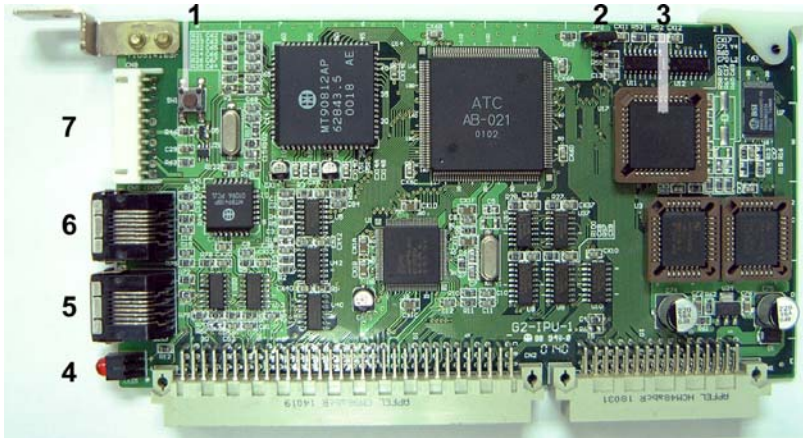

- 1.) SW1: Reset button
- 2.) JP2: Terminators – Keep it at 'Off' position always(Default)



- 3.) Socket for the HDLC controller for bus expansion of multi-cabinet.
- 4.) LED1: Heart beat LED
- 5.) CN6: connector for expanding cabinet
- 6.) CN5: connector for expanding cabinet
- 7.) CN9: LCD connector



Hardware Installation

A. 64 ports (16x48) + 64 ports (16x48)

1. Assume system is powered off.
2. Adjust SW1 on the G2-MBU for both cabinets.

For the 1st cabinet

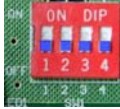

For the 2nd cabinet

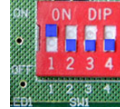

3. Install a G2-MPU2 in the MPU/LMU slot of the 1st cabinet.
4. The IPU should be a G2-IPU2 (HDLC chip on U17) and installed in the IPU slot of each cabinet.

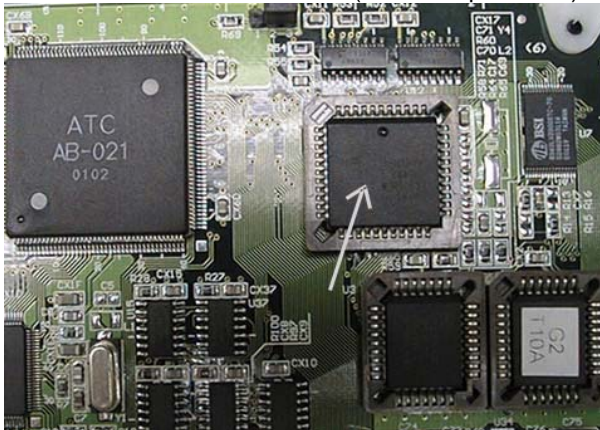

Note: The G2-IPU2 is for multi-cabinet use. The G2-IPU is only for single cabinet use.

5. Connect the expansion cable (short red one) between the G2-MPU2 and the G2-IPU2 in the 1st cabinet as below.

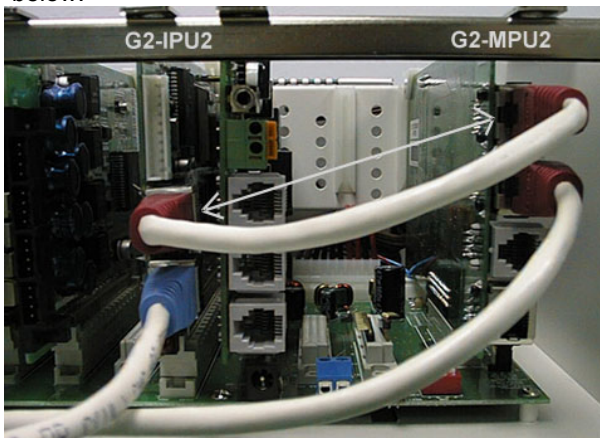

6. Connect the expansion cable (long red one) between G2-MPU2 to the G2-IXU in the 2nd cabinet

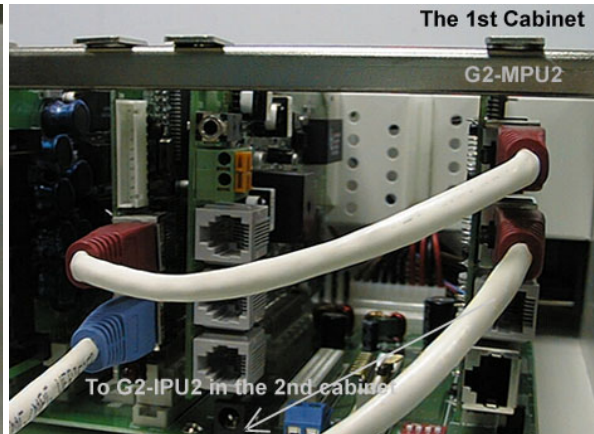
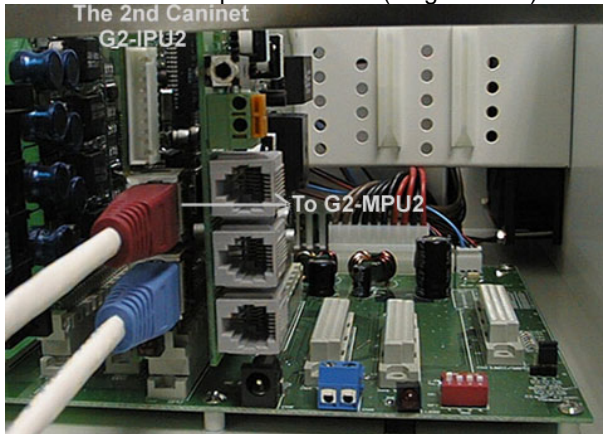

7. Connect the expanding cable (long blue one) between two G2-IPU2s in each cabinet

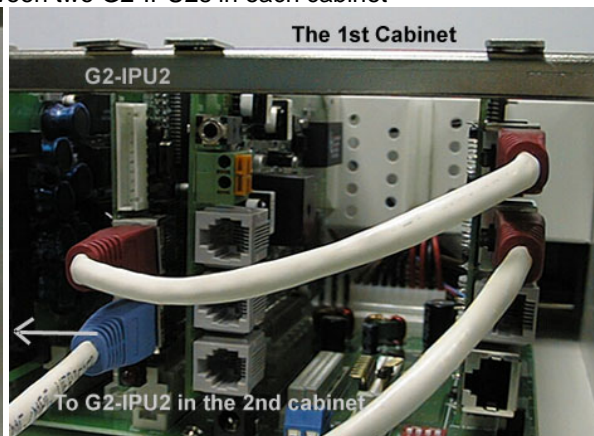
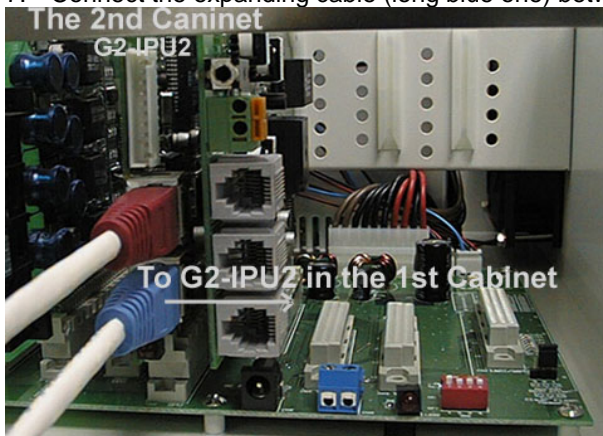

8. Install all other interface cards in cabinets.

9. **Power on the first cabinet first.**

10. Power on the 2nd cabinet Immediately after the first.

B. 64 ports (16x48) + 80 ports (G2-EMD80)

1. Assume system is powered off.
2. Adjust SW1 on G2-MBU for both cabinets.
For the 1st cabinet

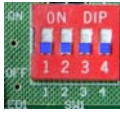

For the 2nd cabinet

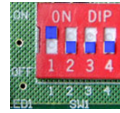

3. Install G2-MPU2 in the MPU/LMU slot of the 1st cabinet.
4. The IPU should be a G2-IPU2 (HDLC chip on U17) and installed in the IPU slot of each cabinet.

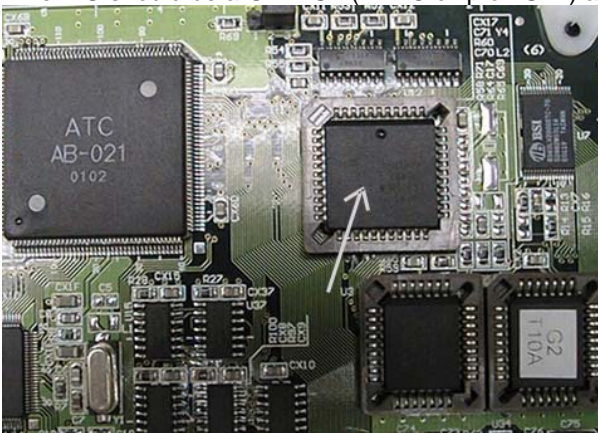

Note: The G2-IPU2 is for multi-cabinet use. The G2-IPU is only for single cabinet use.

5. Install G2-IXU in the IXU slot of the 2nd cabinet (G2-EMD80).
6. Connect the expansion cable (short red one) between G2-MPU2 to the G2-IPU2 in the 1st cabinet as below.

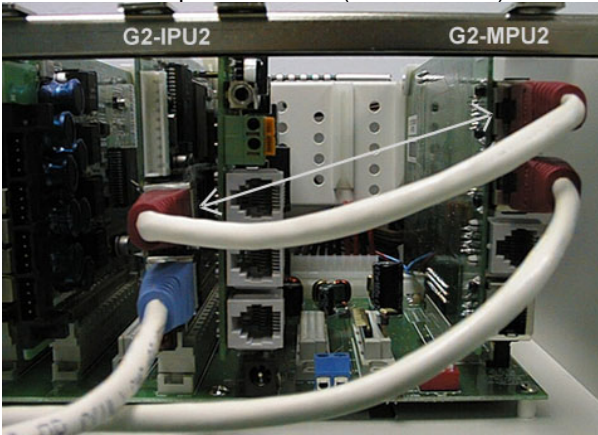

7. Connect the expansion cable (long red one) between the G2-MPU2 and the G2-IXU in the 2nd cabinet

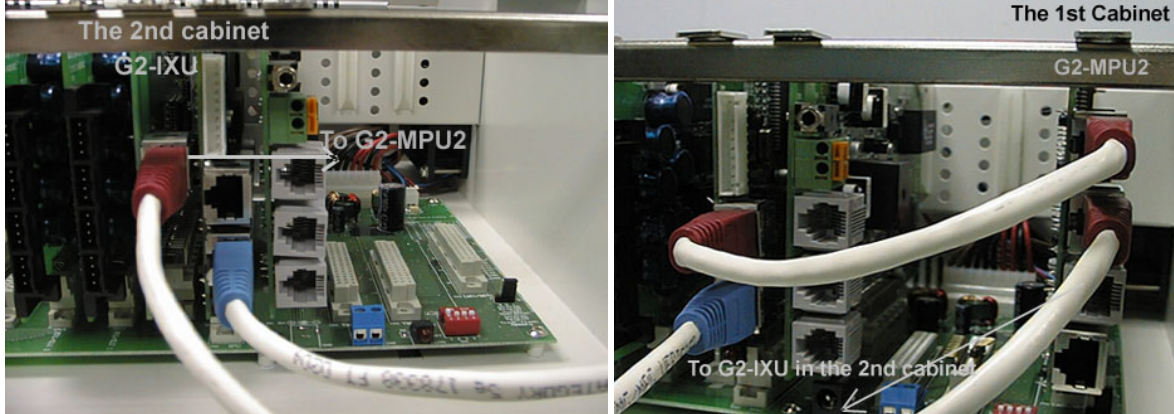

8. Connect the expanding cable (long blue one) between the G2-IPU2 in each cabinet

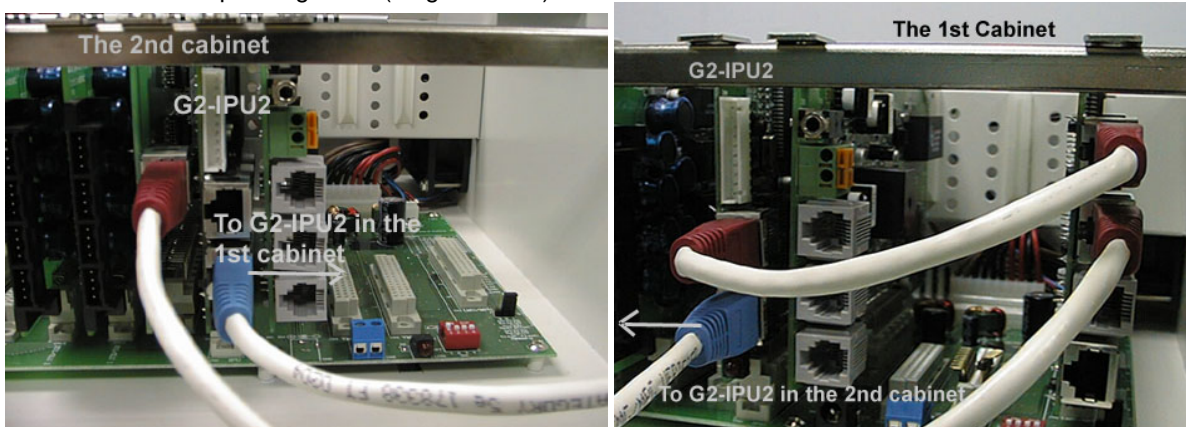

9. Install all other interface cards in cabinets.

10. **Power on the first cabinet first.**

11. Power on the 2nd cabinet immediately after.

C. GDS600 160 ports - 80 Ports (G2-MMD160) + 80 ports (G2-EMD80)

1. Assume system is powered off.
2. Adjust SW1 on G2-MBU for both cabinets.
For the 1st cabinet

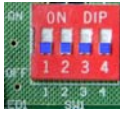

For the 2nd cabinet

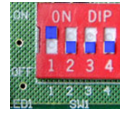

3. Install the G2-MPU2 in the MPU/LMU slot of the 1st cabinet.
4. The IPU should be a G2-IPU2 (HDLC chip on U17) and installed in the IPU slot of each cabinet.

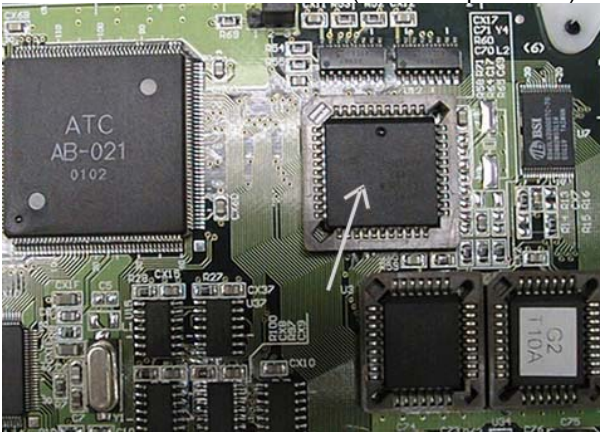

Note: The G2-IPU2 is for multi-cabinet use. The G2-IPU is only for single cabinet use.

5. Install the G2-IXU in the IXU slot of each cabinet (G2-MMD80 and G2-EMD80).
6. Connect the expansion cable (short red one) between the G2-MPU2 and the G2-IXU in the 1st cabinet as below.

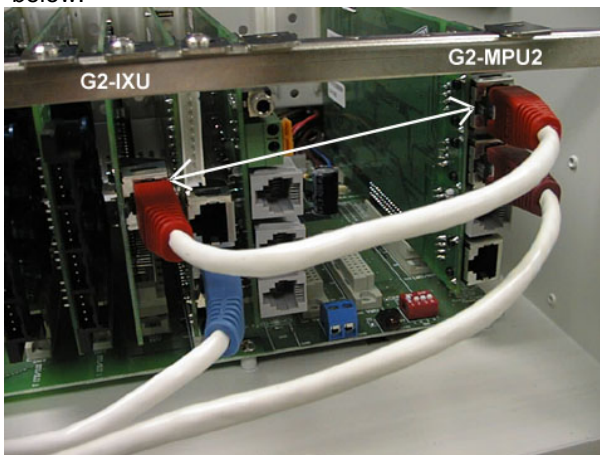

7. Connect the expansion cable (long red one) between the G2-MPU2 and the G2-IXU in the 2nd cabinet

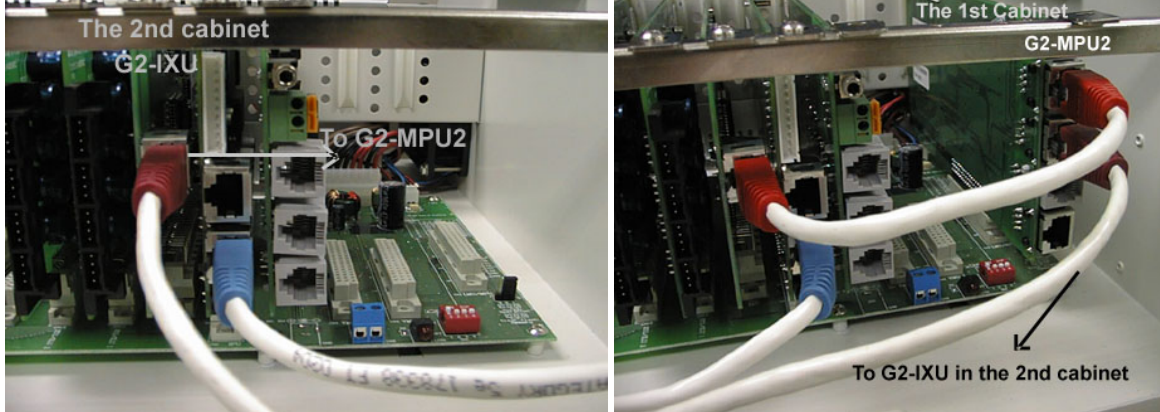

8. Connect the expansion cable (long blue one) between the G2-IPU2s in each cabinet

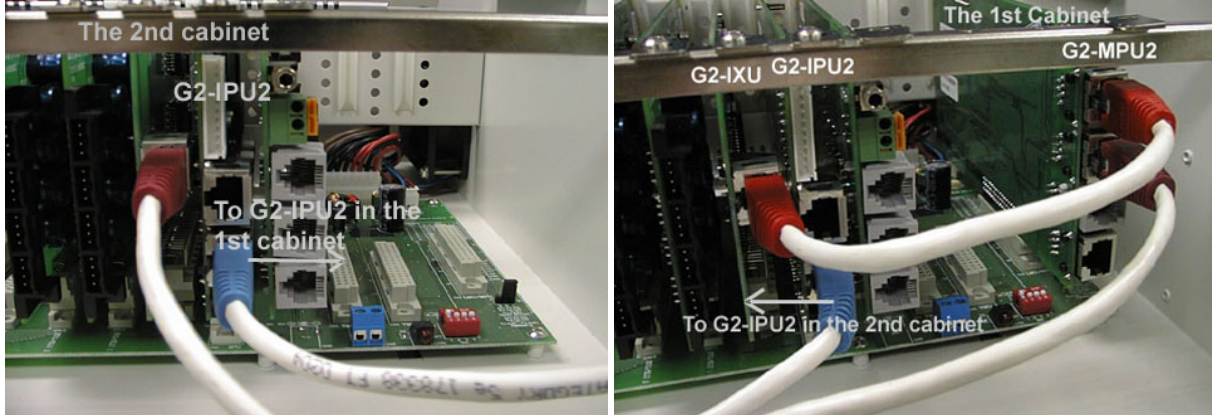

9. Install all other interface cards in cabinets.

10. **Power on the first cabinet first.**

11. Power on the 2nd cabinet immediately after.

D. GDS600 320 ports - 80 ports (G2-MMD320) + 80 ports (G2-EMD80)

1. Assume system is powered off.
2. Adjust SW1 on G2-MBU for all cabinets.
For the 1st cabinet For the 2nd cabinet

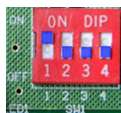
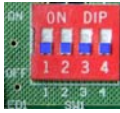

For the 3rd cabinet

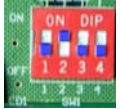

For the 4th

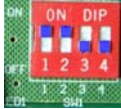

CABINET NO.	SW1			
	1	2	3	4
1	OFF	OFF	OFF	NA
2	ON	OFF	OFF	NA
3	OFF	ON	OFF	NA
4	ON	ON	OFF	NA
5	OFF	OFF	ON	NA
6	ON	OFF	ON	NA
7	OFF	ON	ON	NA
8	ON	ON	ON	NA

cabinet

3. Install the G2-MPU4 in the MPU/LMU slot of the 1st cabinet.
4. Install the G2-MXU4 in the first VMU slot of the 1st cabinet.
5. Connect the flat cable between the G2-MPU4 and the G2-MXU4 as below.

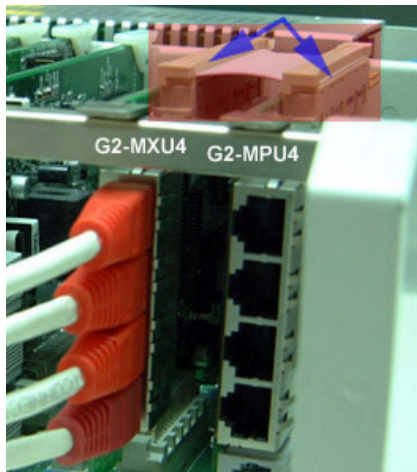

6. The IPU should be a G2-IPU2 (HDLC chip on U17) and installed in the IPU slot of each cabinet.

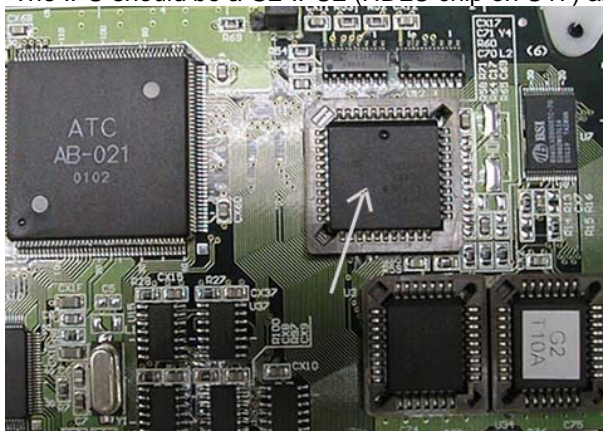

Note: The G2-IPU2 is for multi-cabinet use. The G2-IPU is only for single cabinet use.

7. Install a G2-IXU in the IXU slot of each cabinet (G2-MMD320 and G2-EMD80).
8. Connect the expansion cable (short red 1) from the G2-MXU4 and the G2-IXU in the 1st cabinet as below.
 Connect the expansion cable (long red 2) from the G2-MXU4 and the G2-IXU in the 2nd cabinet as below.
 Connect the expansion cable (long red 3) from the G2-MXU4 and the G2-IXU in the 3rd cabinet as below.
 Connect the expansion cable (long red 4) from the G2-MXU4 and the G2-IXU in the 4th cabinet as below.

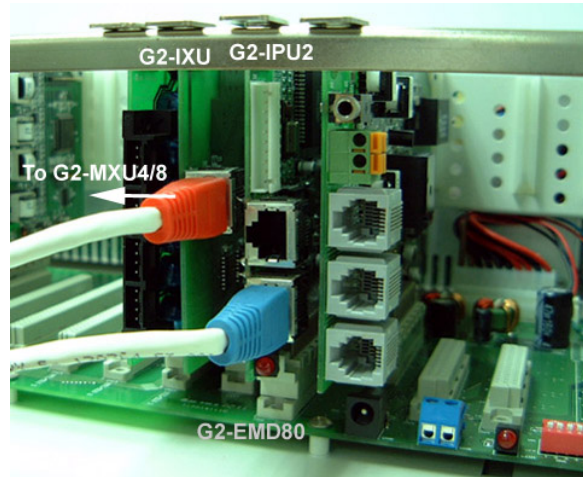
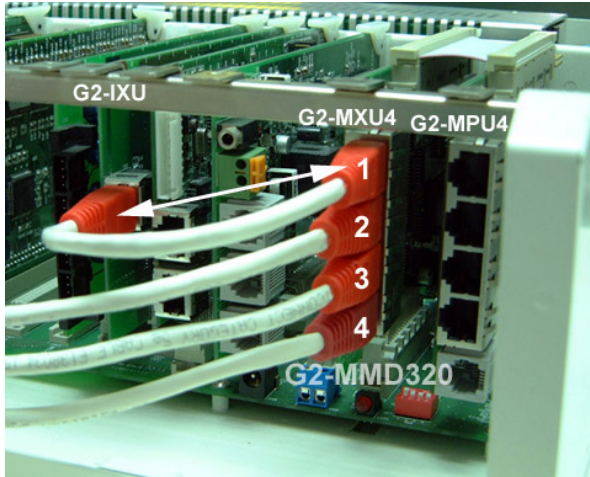

9. Connect the expansion cable (long blue '2') between the G2-MPU4 and the G2-IPU2 in the 2nd cabinet.
 Connect the expansion cable (long blue '3') between the G2-MPU4 and the G2-IPU2 in the 3rd cabinet.
 Connect the expansion cable (long blue '4') between the G2-MPU4 and the G2-IPU2 in the 4th cabinet.

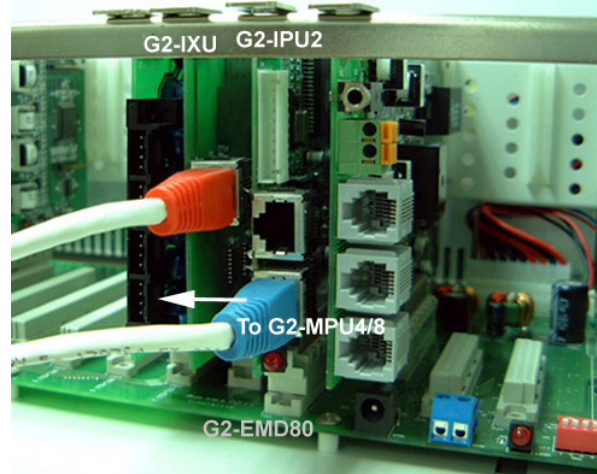

10. Install all other interface cards in cabinets.
11. **Power on the first cabinet first.**
12. Power on the 2nd, 3rd, 4th cabinet immediately after.

Note:

- The attached expansion cables:
1. Short red expansion cable
 2. Long red expansion cable
 3. Long blue expansion cable

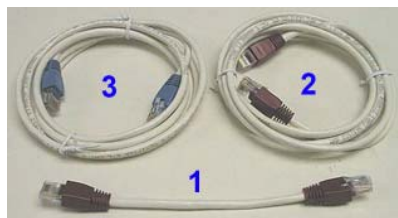

E. GDS600 640 ports - 80 ports (G2-MMD640) + 80 ports (G2-EMD80)

1. Assume system is powered off.
2. Adjust SW1 on G2-MBU for all cabinets.

For the 1st cabinet

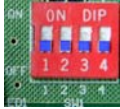

For the 2nd cabinet

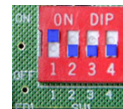

For the 3rd cabinet

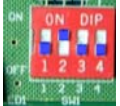

For the 4th cabinet

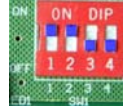

For the 5th cabinet

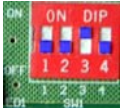

For the 6th cabinet

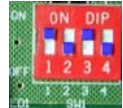

For the 7th cabinet

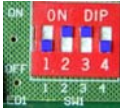

For the 8th cabinet

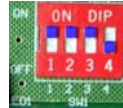

CABINET NO.	1	2	3	4
1	OFF	OFF	OFF	NA
2	ON	OFF	OFF	NA
3	OFF	ON	OFF	NA
4	ON	ON	OFF	NA
5	OFF	OFF	ON	NA
6	ON	OFF	ON	NA
7	OFF	ON	ON	NA
8	ON	ON	ON	NA

3. Install the G2-MPU8 in the MPU/LMU slot of the 1st cabinet.
4. Install the G2-MXU8 in the first VMU slot of the 1st cabinet.
5. Connect the flat cable between the G2-MPU8 and the G2-MXU8 as below.

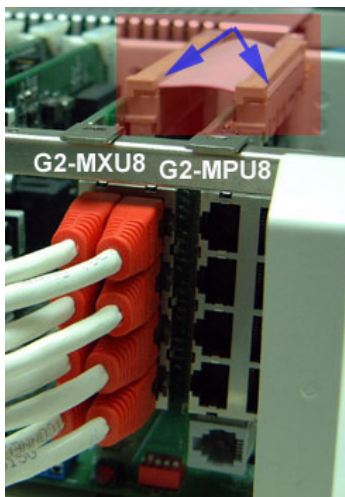

6. Install the G2-IPU2 (HDLC chip on U17) in the IPU slot of each cabinet.

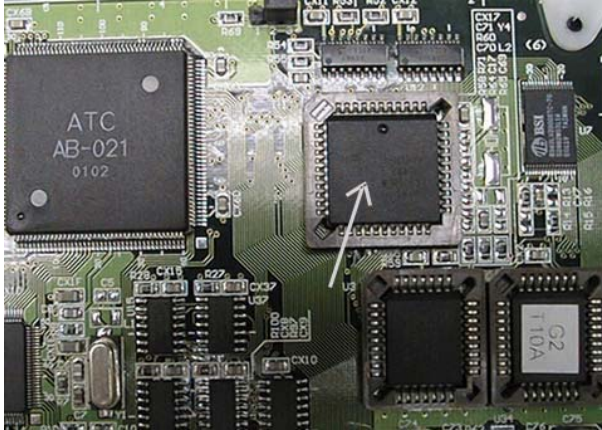

Note: The G2-IPU2 is for multi-cabinet use. The G2-IPU is only for single cabinet use.

7. Install the G2-IXU in the IXU slot of each cabinet (G2-MMD640 and G2-EMD80).
8. Connect the expansion cable (short red 1) from the G2-MXU8 to the G2-IXU in the 1st cabinet as below.
Connect the expansion cable (long red 2) from the G2-MXU8 to the G2-IXU in the 2nd cabinet as below.
.....
Connect the expansion cable (long red 7) from the G2-MXU8 to the G2-IXU in the 7th cabinet as below.
Connect the expansion cable (long red 8) from the G2-MXU8 to the G2-IXU in the 8th cabinet as below.

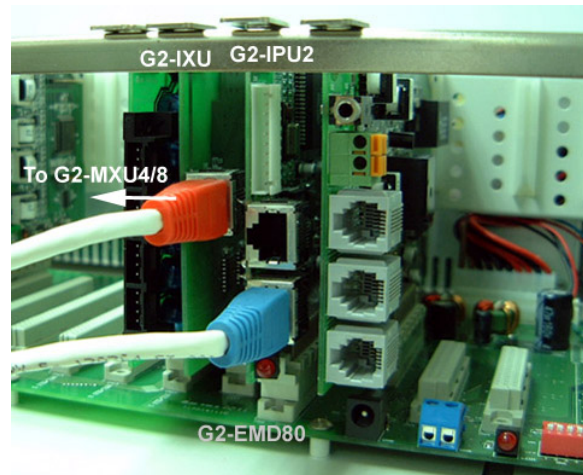
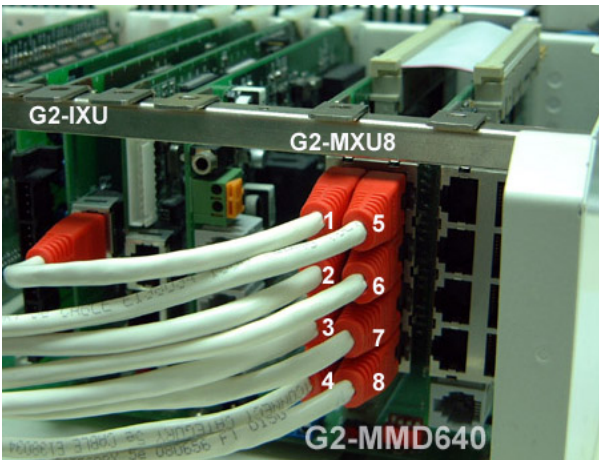

9. Connect the expansion cable (long blue '2') from the G2-MPU8 to the G2-IPU2 in the 2nd cabinet.
Connect the expansion cable (long blue '3') from the G2-MPU8 to the G2-IPU2 in the 3rd cabinet.
.....
Connect the expansion cable (long blue '8') from the G2-MPU8 to the G2-IPU2 in the 4th cabinet.

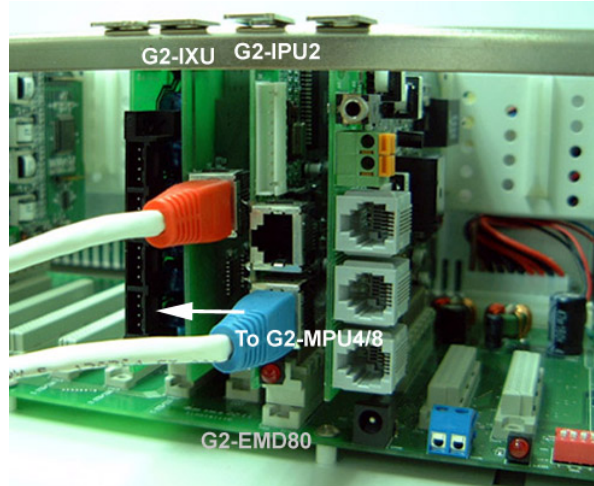
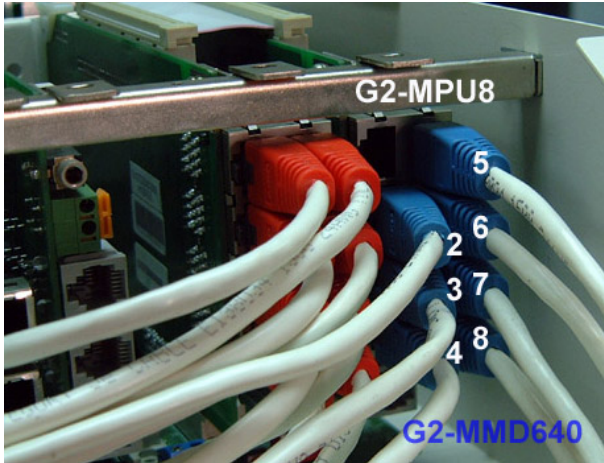

10. Install all other interface cards in cabinets.
11. **Power on the first cabinet first.**
12. Power on the 2nd, 3rd, 4th, 5th, 6th, 7th, 8th cabinet immediately after.

Note:

- The attached expansion cables:
4. Short red expansion cable
 5. Long red expansion cable
 6. Long blue expansion cable

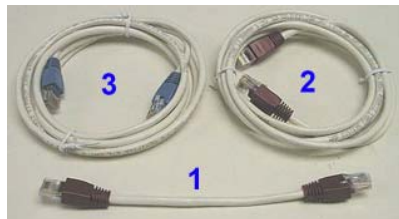

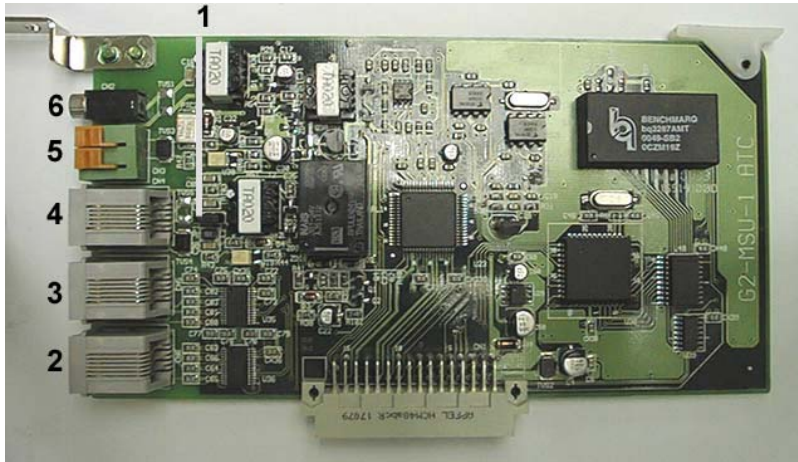
G2-MSU- Multi Service Card**JP1: Grounding Jumper for specific external paging devices**

This is unlikely to be needed for most equipment.

JP1 No Grounding
1 2 3 (Default)

JP1 Grounding
1 2 3

- 1.) Grounding Jumper
- 2.) MODEM connector for the external MODEM connection to the system
- 3.) RS232 connector
- 4.) Relay / Sensor / External Paging connector
- 5.) CN3: Door Phone Interface (for DPU05)
- 6.) CN2: External Music on Hold Interface

G2-VMU- Voice Mail Service Card

- Install the G2-VMU card in the VMU1 or VMU2 slot of the G2-MBU.

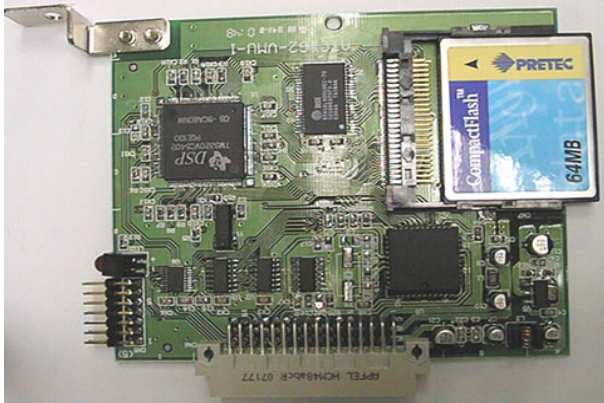

G2-STU Digital Station Card

- Install the G2-STU card in STU1, STU/SLU2, ..., STU/SLU5 slot of the G2-MBU. The STU card has 4 digital twin ports allowing 2 stations to be paralleled of each port. It is highly recommended that all extensions are home run back to individual inner and outer pairs directly on the DDK connector.

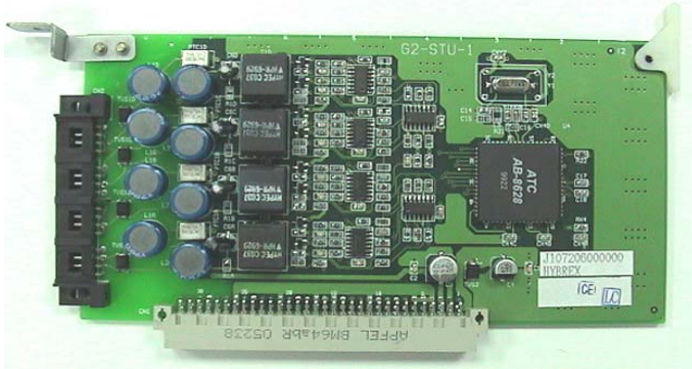

G2-STU2 Digital Station Card

- Install the G2-STU2 card in STU1, STU/SLU2, ..., STU/SLU5 slot of the G2-MBU.
- The STU2 card has 8 individual digital ports. It is necessary that all extensions are home run back to individual inner and outer pairs directly on the DDK connector. Digital phones can not be paralleled of a STU2 card port. A G2-STU2 card can be hot swapped if the system software supports this feature.

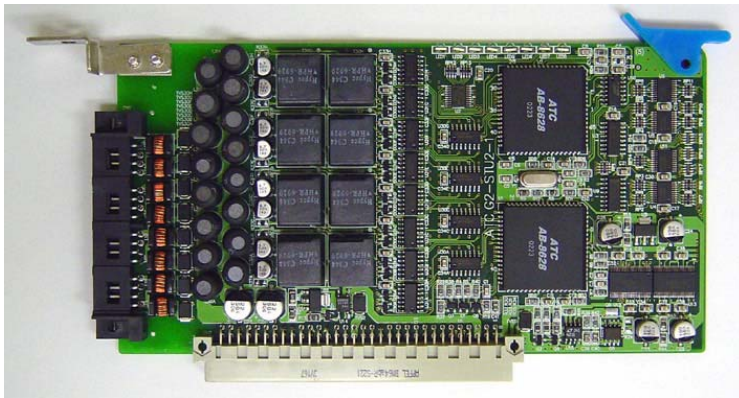

G2-SLU Analog Station Card

- Install the G2-SLU card in STU/SLU2, ..., STU/SLU5, SLU6 slot of the G2-MBU.
- SLT ports on this card support Message Wait, CID to extensions

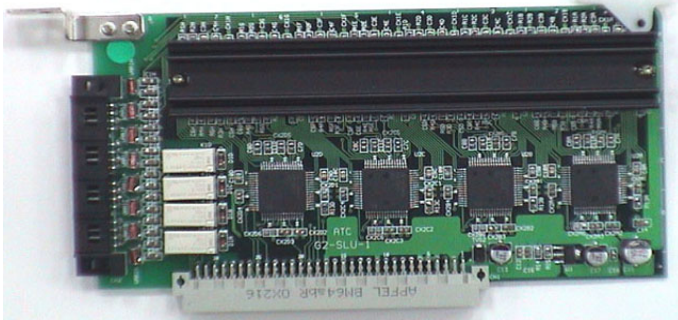

G2-HSU-44 4 Digital/4 Analogue Card

- The HSU 44 card has 4 Analogue ports and 2 Digital twin ports. The first 4 ports are Analogue and the last 2 are digital. The SLT ports have all the features of SLT ports on the G2-SLU.
- Install the G2-HSU-44 card in STU/SLU2, ..., STU/SLU5, SLU6 slot of the G2-MBU.

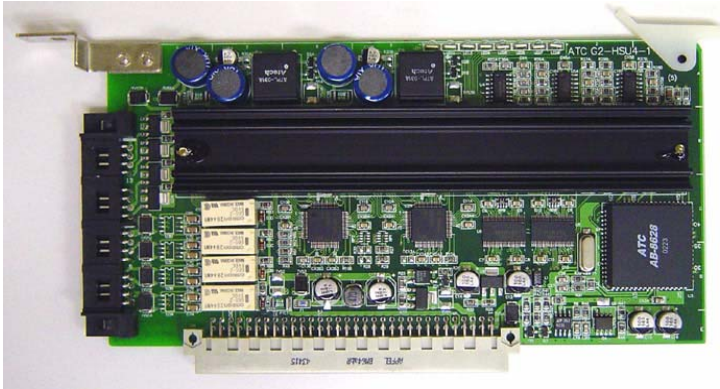

G2-TKU- 4 Port CO Line Card and G2-CIC- Caller ID Card

- Install the G1-CIC card or G1-MDC card on the G2-TKU (optional).
- Install the G2-TKU card in TKU1/TKU2/TKU3/TKU4/(TKU5) slot of the G2-MBU.
- Adjust JP1 of G1-CIC card for G2 use. Install the G1-CIC card on CN6/CN7 of G2-TKU card. Mis-alignment could damage both cards or the system.

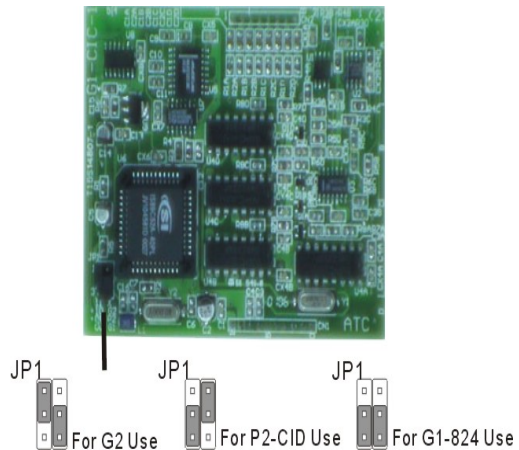
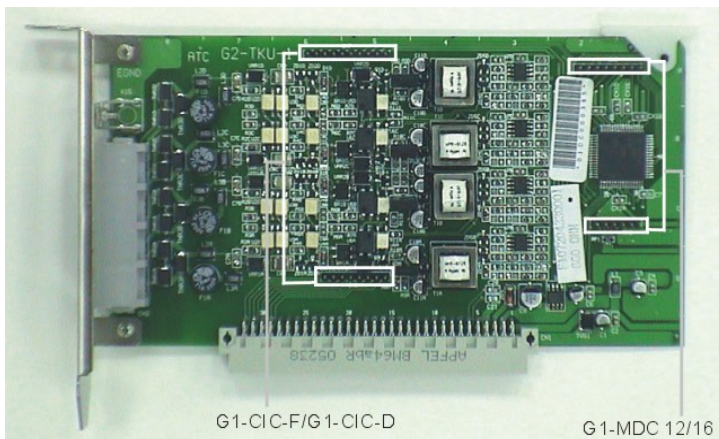

CN6/CN7: G1-CIC-D/G1-CIC-F

G2-TKU2 8 Port Trunk Card and G2-CIC-2 Caller ID Card

- Install the G1-CIC card or G1-MDC card on the G2-TKU (optional).
- Install the G2-TKU card in the TKU1/TKU2/TKU3/TKU4/(TKU5) slots of the G2-MBU.



G2-VIU Voice Over IP Card

- Install the G2-TKU card in the TKU1/TKU2/TKU3/TKU4/(TKU5) slots of the G2-MBU.
- VIU cards can be either SIP or MGCP depending on the firmware installed.



G2-SIU ISDN S/T Interface Card

- Install the G2-SIU card in TKU1/SIU1 or TKU2/SIU2 slots of the G2-MBU.

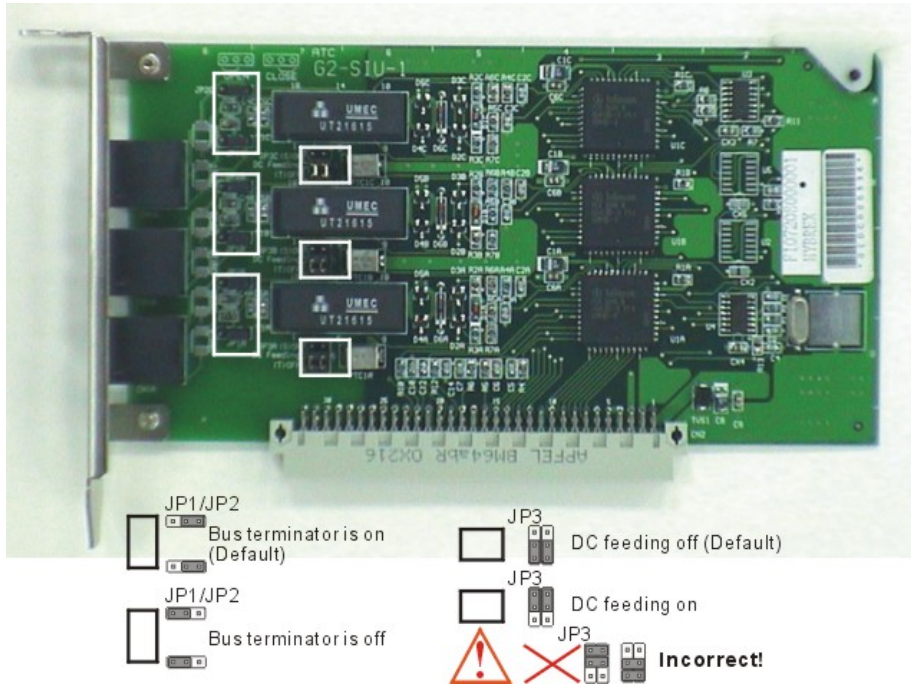

JP3(A,B,C): DC feeding jumper. Default is no DC output. If the internal ISDN device does not offer local power and needs DC feeding to work. The related jumper of this internal ISDN interface needs to be set to “on”.

Caution:

1. When this jumper is on, users cannot loop “S” interface back to another “T” interface for testing purposes. Otherwise, it will damage this card!
2. Incorrect jumper settings will also damage this card.

JP1(A,B,C)/JP2(A,B,C): Bus Terminator.

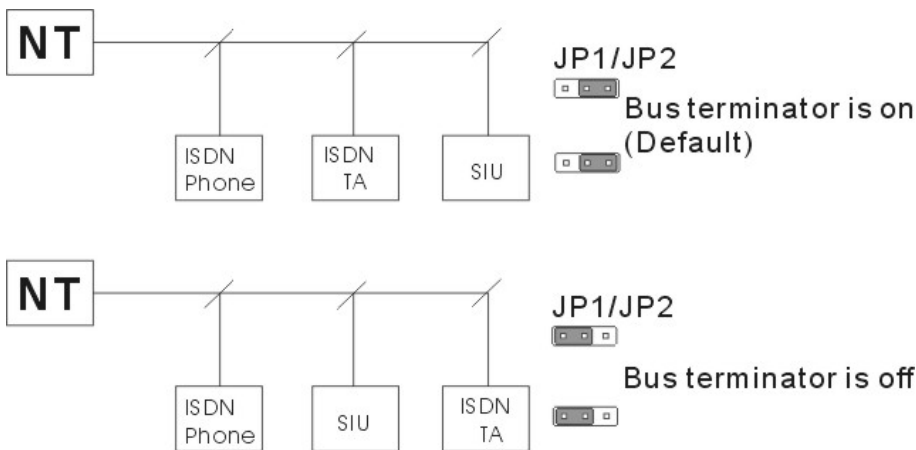

G2-PIU ISDN PRI / T1 / E1 Interface Card

- Install the G2-PIU card in the TKU1/SIU1 slot of the G2-MBU.
- The slot immediately after the G2-PIU card must be left vacant.
- If the PIU card has 30 channels connected in a 64 port cabinet then the STU/SLU 1 slot must be left vacant. Which limits the Extension capacity of the 64 port cabinet to 40.

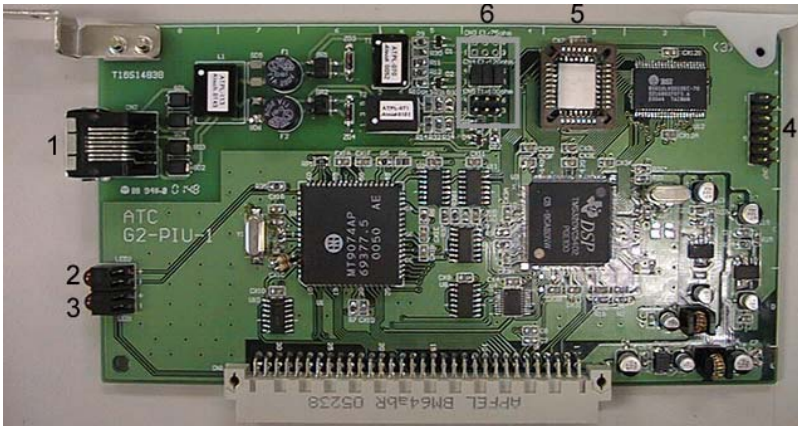

1. RJ 45 Connector:
Pin 1,2: for TX.
Pin 4,5: for RX.
2. LED 2: For network Sync indication.
 1. Off: No connection.
 2. Flash: There is no sync.
 3. On: Sync OK.
3. LED 1: For the heart beat of the DSP chip.
4. CN7: For test purposes.
5. DSP chip for T1/E1 interface.
6. CN4/CN5:
Jumpers on CN4 are for the E1 interface and the ISDN PRI/E1 interface.
Jumpers on CN5 are for the T1 interface and the ISDN PRI/T1 interface.

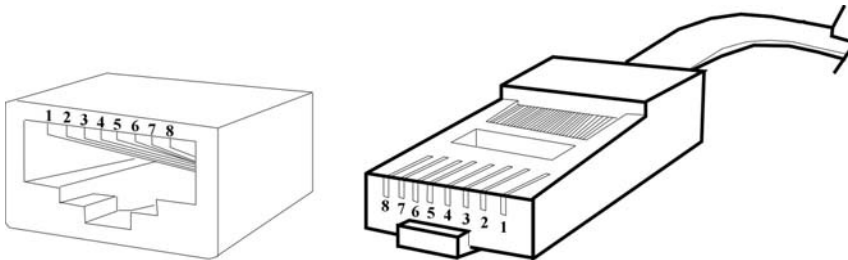

Voltage Selection Check

- Check to ensure the power supply jumper setting is for the proper voltage.
- When complete, place the power supply cover back on the power supply.



Replace Fuses of Power Supply

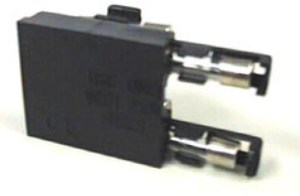

Replace Cover

With the expansion and option cards installed and the battery insulator removed, replace the cover and install the 4 screws removed earlier.

This concludes the installation of expansion and option cards!

Preparing the External Battery Backup

The Key Service Unit can have two battery backup devices BBOX1 connected for emergency power when a power failure takes place.



If you are installing an optional Battery Backup (BBOX1), make certain that there is adequate room for its installation. Make certain that the Battery Backup is mounted close enough to the Power Supply that the interconnecting cable between the Battery Backup and the Power Supply can connect.

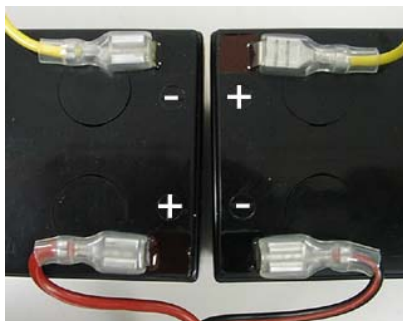

Do Not Connect the Battery Backup at this time!

Do Not Connect the Battery Backup at this time! Battery Backup should not be connected to the System power supply until all power up testing has been completed!

Charging the Battery

The rechargeable batteries are automatically charged when the KSU is plugged in. When System is in a full-load condition (eight CO Trunks and twenty-four Extensions all in use), the batteries provide a minimum of 1 hour's consecutive use. Change the batteries every two years.

Installing or Replacing Batteries

Caution

To Reduce the Risk of Fire or Injury to persons, Read and Follow these Instructions.



1. Use only the following type and size batteries:
12 Volt 6.5 Amp/Hour "Gel-Cell" sealed batteries (2).
Dimensions, approximately 3 1/4" (H), 5 15/16" (W), 2 1/2" (D).
PowerSonic model PS660 or equivalent.
2. Do not dispose of the batteries in a fire. The cell may explode.
Check with local codes for possible special disposal instructions.
3. Do not open or mutilate the batteries. Released electrolyte is corrosive and may cause damage to the eyes or skin. It may be toxic if swallowed.
4. Exercise care in handling batteries in order not to short the battery with conducting materials such as rings, bracelets, and keys. The battery or conductor may overheat and cause burns.

This product is defined as a secondary battery operated device. As such, the following instructions should also be read and followed:

1. Charge the batteries provided with or identified for use with this product only in accordance with the instructions and limitations specified in this manual.
2. Observe proper polarity orientation between the batteries and battery charger.
3. Do not mix old and new batteries in this product.
4. Do not mix batteries of different sizes or from different manufacturers in this product.

Before installing or replacing batteries, disconnect the battery supply unit to the KSU by removing the polarized battery connector at the KSU. Due to the weight of the batteries, it is advised that the battery cabinet be removed from the wall before working on it.

System Ground

It is strongly recommended that the system be grounded by connecting a heavy, insulated copper wire (e.g., 14AWG or larger) between the grounding bolt on the right-lower side of the cabinet and an earth ground. Without this System Ground there is no protection against lightning damage to Co lines and warranty will be voided. Do not connect the grounding wire of the KSU to a computer, telex, or any other external device.



Connecting Stations

The station cabling for the GDS-600 should be a home run from the jack to the telephone room. The termination should be at conventional 66 type connecting blocks or Krone or directly to the provided station connectors. One pair twisted wiring is required for each station location. Attention to proper cabling will go a long way towards a successful installation and minimizing service calls after installation.

Each extension should be wired individually back to the inner and outer pairs of the DDK connector on the station card and not paralleled external to the system with one pair back to the DDK connector. This will ensure that the protection circuit on the output of the STU card will operate to isolate each extension from adverse effects of plugging/unplugging extensions.

Some guidelines for running station cable are as follows:

- Avoid running cable parallel to fluorescent light fixtures or electrical lines not in conduit. If these obstacles are unavoidable, run the cable at right angles across them.
- Do not run station cable inside conduit already occupied by electrical wiring.
- Do not run station cable near equipment with electric motors or strong magnetic fields.
- Do not place station cable on the ground where it can be stepped on or rolled over by office furniture or office equipment.

Digital Key Telephone – DK1-21/22/31/32/33

- Terminate the station wires with the connectors that are provided. The stations will connect to the G2-STU of KSU.
- Connect Tip terminal with GRN terminal (screws) of the modular jack, Ring with RED.
- There is no polarity requirement on Tip and Ring.
- 2-conductor wiring is required for DK1 Digital Key Telephones.
- Open the overlay of the function key on DK1 telephone and select the 1st or 2nd station. Dip switch to the right for the 1st station. Dip switch to the left for the 2nd station.

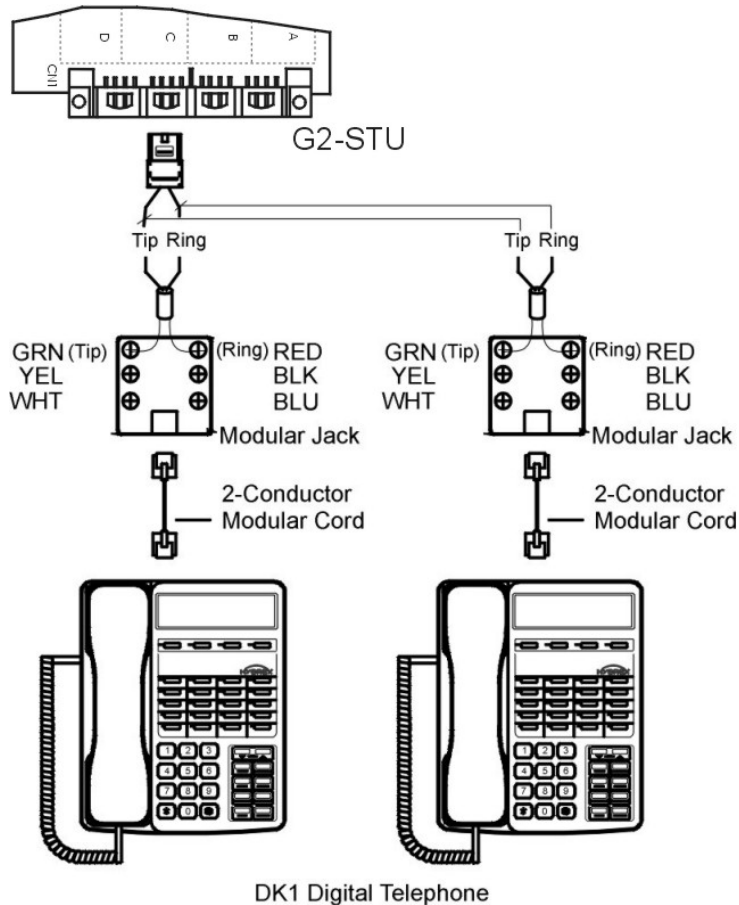

Dip to right: the 1st station.
Dip to left: the 2nd station.

CAUTION!: Avoid shorting Tip and Ring together. It may damage the G2-MBU or G2-STU board.

Digital Key Telephone – DK1-21H

- Terminate the station wires with the connectors that are provided. The stations will connect to the **G2-STU** of KSU.
- Connect Tip terminal with GRN terminal (screws) of the modular jack, Ring with RED.
- There is no polarity requirement on Tip and Ring.
- **4-conductor wiring** is required for the DK1-21H Digital Key Telephones from the Handset to the Wall socket.
- Open the overlay of the function key on the DK1-21H telephone and select the 1st station.
- Connect the single line telephone from the phone box. Connect Tip terminal with YEL terminal (screws) of the modular jack, Ring with BLK..

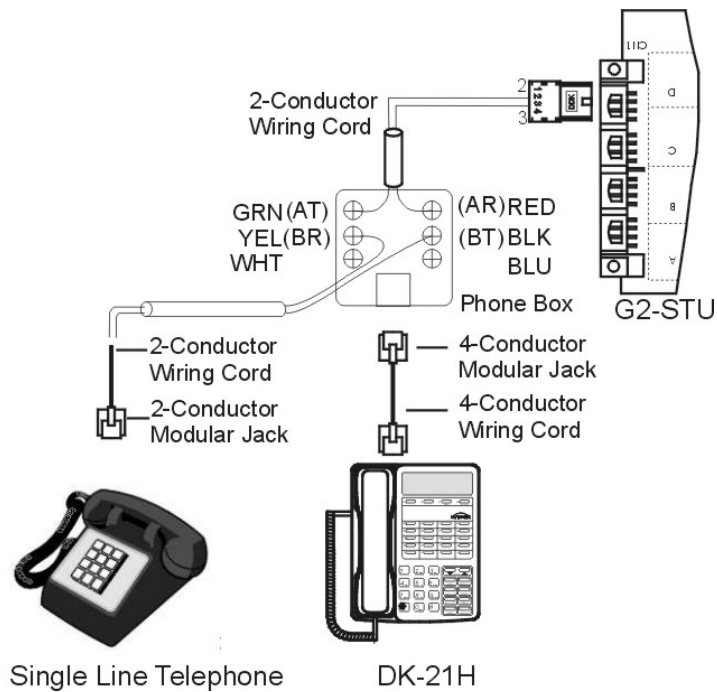

Dip to right on DK1-21H

CAUTION!

1. Avoid shorting Tip and Ring together. It may damage the G2-MBU or G2-STU board.
2. The system does not allow another Digital key phone to be connected on the same digital twin port as a DK1-21H.

Access Control Telephone – ACP

- Terminate the station wires with the connectors that are provided. The stations will connect to the **G2-STU** of the KSU.
- Connect Tip/Ring terminals from KSU(G2-STU) to the ACP connector (6 contacts).
- There is no polarity requirement on Tip and Ring.
- Connect Relay for applications such as door open to the ACP connector (6 contacts).
- Connect Sensor for applications such as door open alarm to the ACP connector (6 contacts).
- Mount ACP connector on ACP itself.
- Select the 1st or 2nd station. Jumper as below diagram showed.
- Mount ACP on the wall.

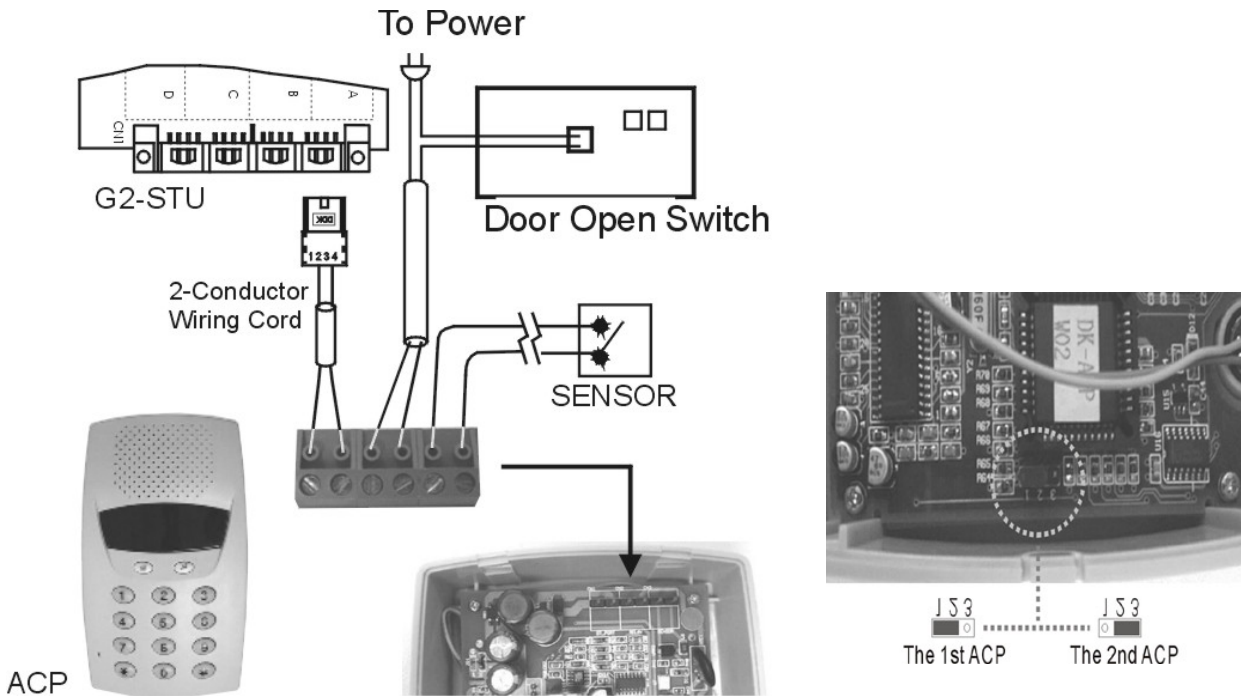

CAUTION! Avoid shorting Tip and Ring together. It may damage the G2-MBU or G2-STU board.

Incorrect wiring

Do not use incorrect wiring as shown below as it will disturb the digital signal of digital telephones.

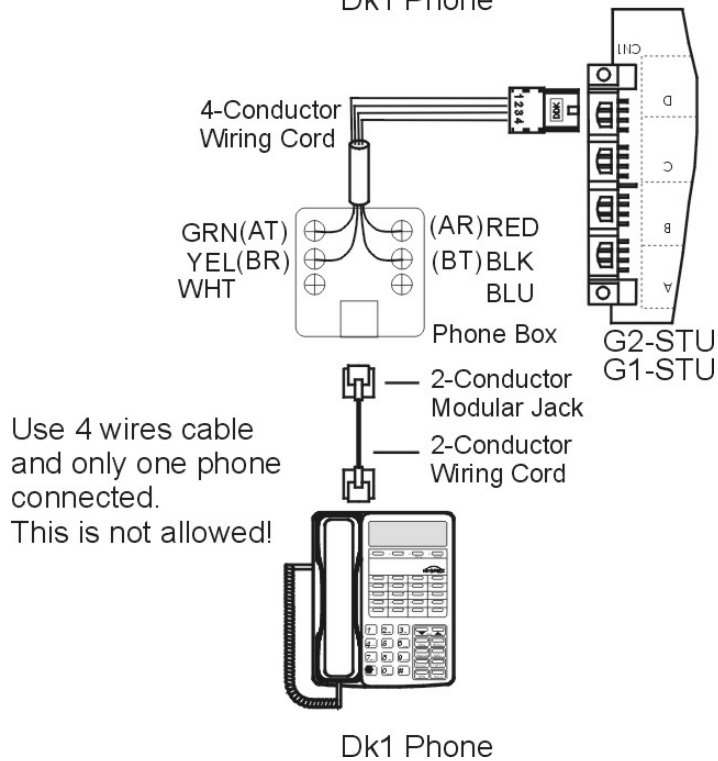
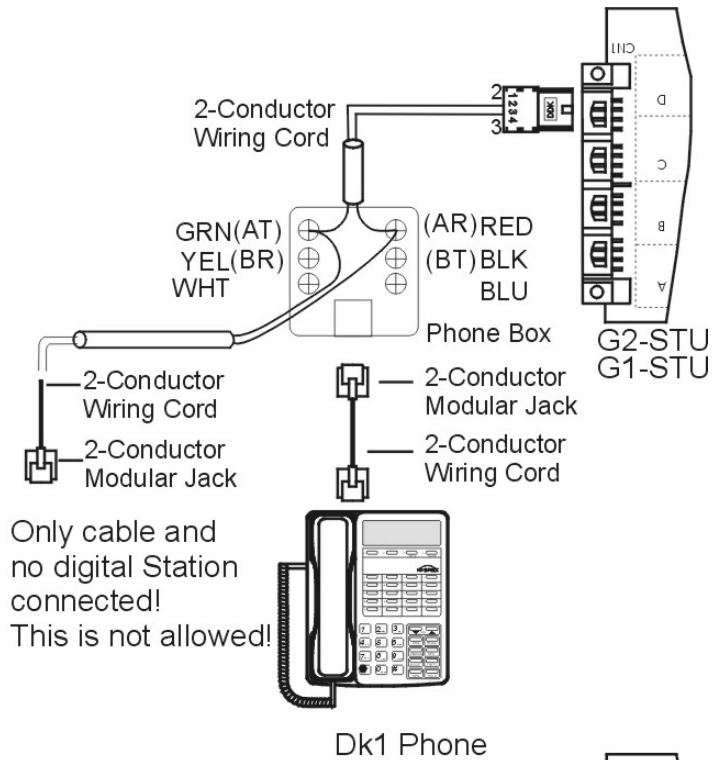

Single Line Telephone (connected to G2-SLU)

- Terminate the station wires with the connectors that are provided. The stations will connect to the KSU through the G2-SLU.
- Connect Tip terminal with GRN terminal (screws) of the modular jack, Ring with RED.
- There is no polarity requirement on Tip and Ring.
- 2-conductor wiring is required for Single Line Telephones.

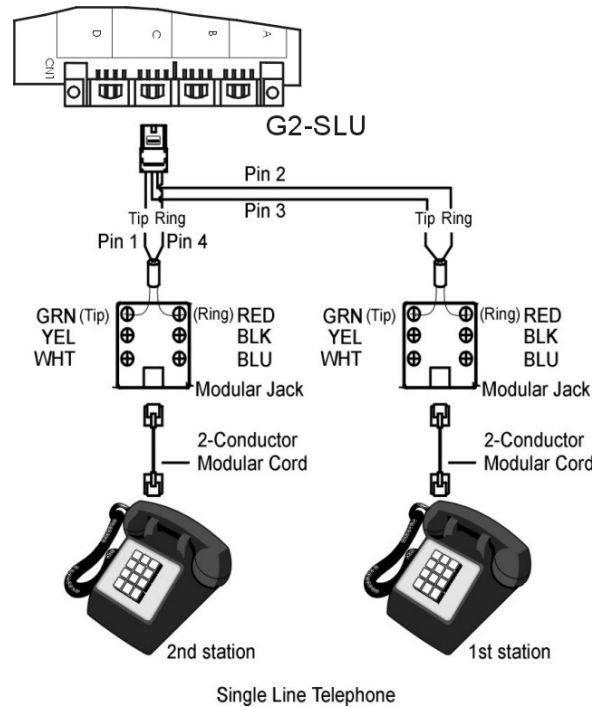

Door Phone Connection

- One Analogue Door phone may be connected to the GDS-600 system.
- A cable cover is provided with the KSU. Door phone cable can enter from bottom only. Remove the cover and route the door phone cable through the hole. Terminate the door phone wires with the connectors that are provided. The Door phone will connect to the G2-MSU (Refer to G2-MSU introduction).
- Connect Tip terminal with GRN terminal (screws) of the modular jack, Ring with RED.
- No polarity on Tip and Ring.
- 2-conductor wiring is required for the Door phone.

Single Line Telephone (connected to DK-SLD)

- Terminate the station wires with the connectors that are provided. The stations will connect to the G2-STU of the KSU.
- Connect Tip terminal with GRN terminal (screws) of the modular jack, Ring with RED.
- There is no polarity requirement on Tip and Ring.
- 2-conductor wiring is required for the DK-SLD Single Line Telephone Adapter.
- Distribute two cords for two single line telephones.

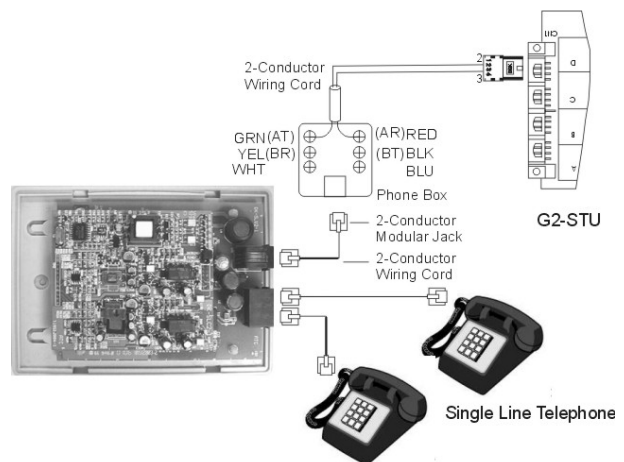

CO/PABX Connections

- Make your CO line connection to the telephone company on this connector. Pins 3 and 4 of the connector are for the CO line.
- RJ-11C (2 wire) modular connector is required.
- 2-conductor wiring is required.

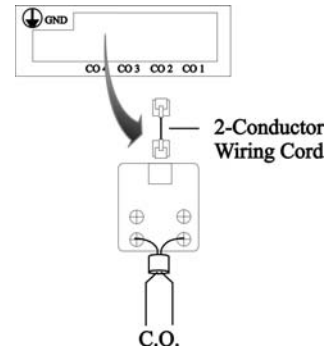

ISDN S/T Connections

- Make your CO line connection to the telephone company on this connector. Pins 3 to 6 of the connector are for the CO line.
- Cable: Twisted 2 pairs
- Connector Type: RJ-45 (4 wire) modular connector is required.
- Connector PIN assignment: (Pin 1, 2, 7, 8 are reserved.)

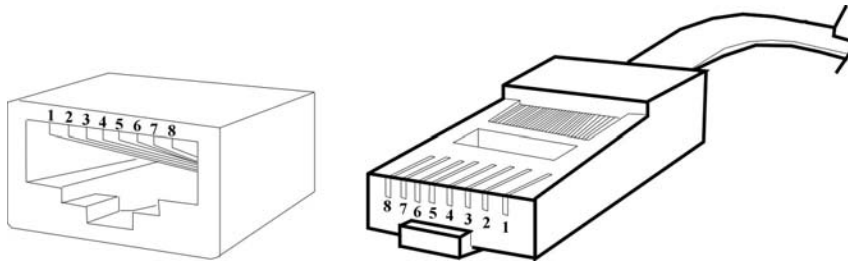

- Install/remove the terminators by adjusting the jumper JP1 (A, B, C) and JP2 (A, B, C) on SIU card. If there is no other ISDN device connected after the ISDN interface of SIU card when using point to multi-point connection, this ISDN interface port needs the terminator installed. Otherwise, remove the terminator.

Example:

The following is the point to multi-point connection.

- The 1st ISDN interface needs the terminator because there is no other ISDN device connected after this ISDN interface of SIU card.
- The 2nd ISDN interface does not need the terminator because there is an ISDN Modem connected after this ISDN interface of SIU card.

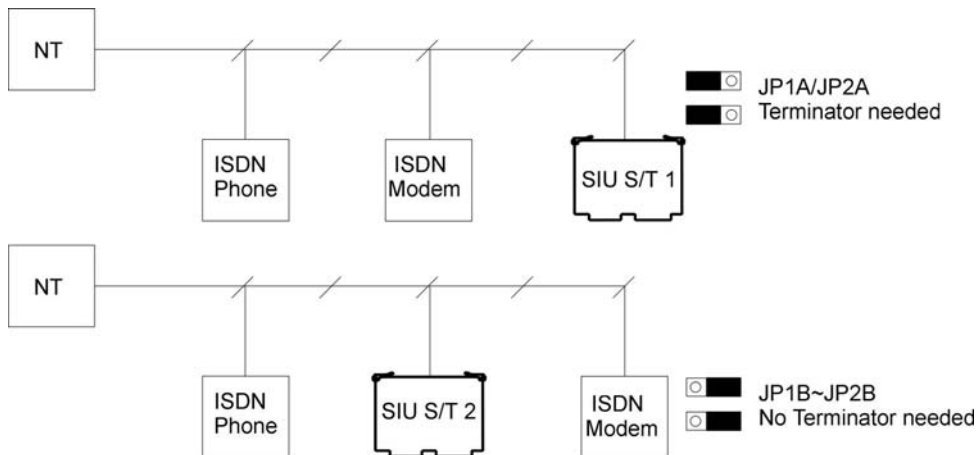

- **T-Interface Connection:**
If the user has programmed the ISDN interface of SIU to a T-Interface, the wiring should be as follows:

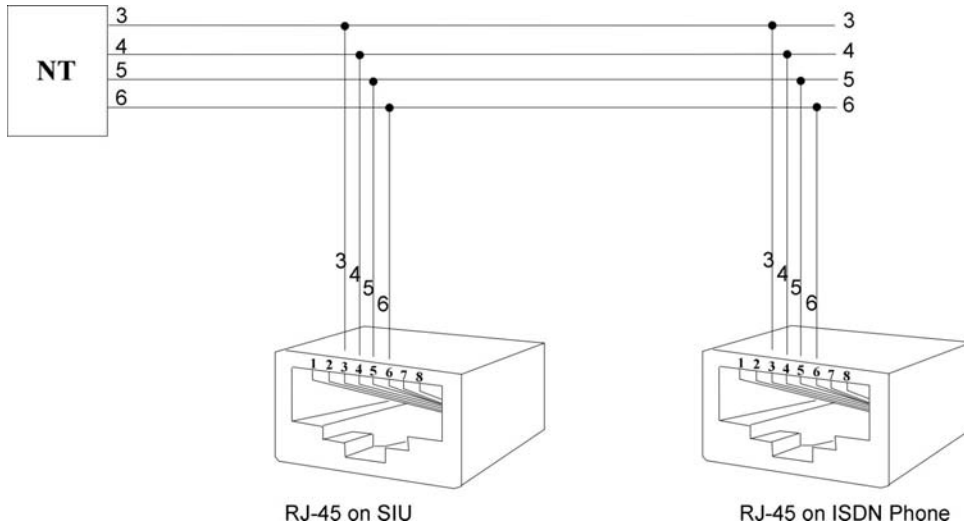

- **S-Interface Connection:**
If the user has programmed the ISDN interface of SIU to a S-Interface, the wiring should be as the following:

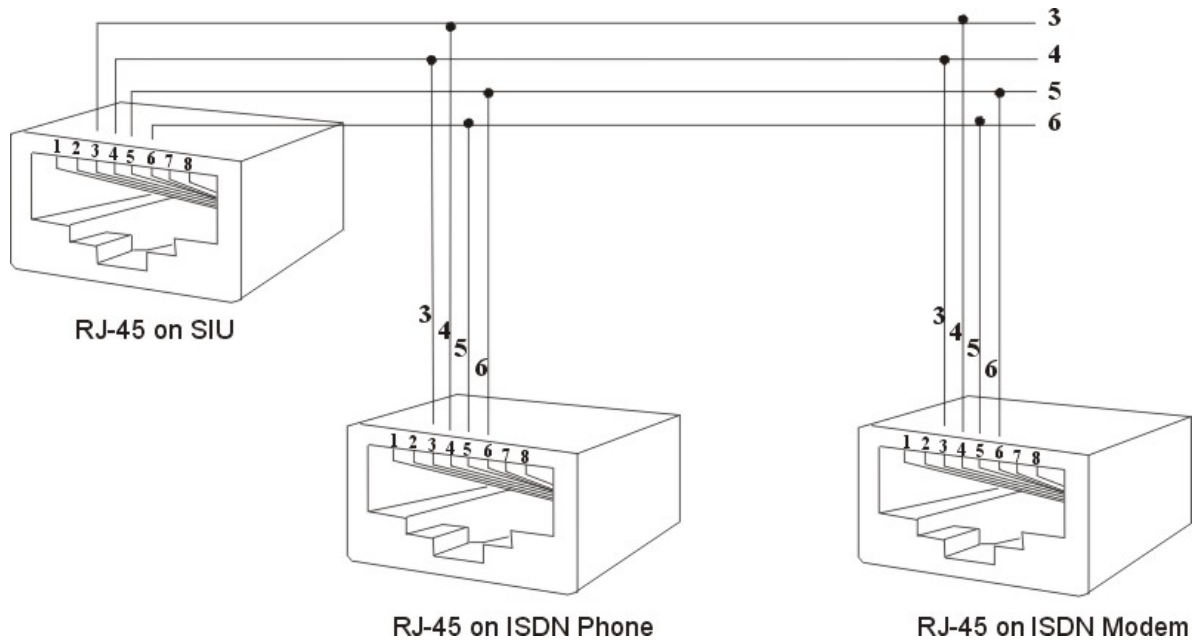

• Bus Configurations on the S/T Interface:

Point to Point:

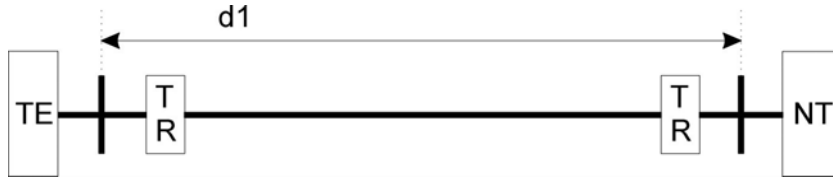

d1: 750m ~ 1000m; Length limitation by attenuation of 6dB at 96kHz.

Short Passive Bus:

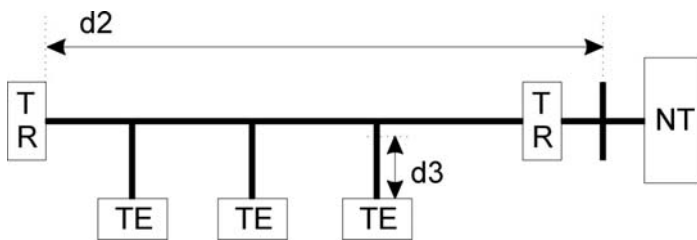

d2: 100m ~ 200m; Length limitation by round trip delay 10us to 14us, not by attenuation.

d3: Recommendation with a cord having a minimum length of 5m and not more than 10m. (5m $d3$ 10m)

Extended Passive Bus:

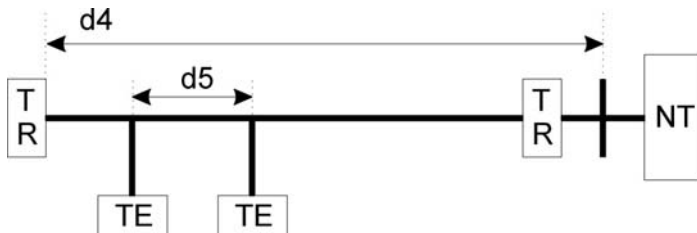

d4: 500m ~ 800m; Length

limitation by round trip delay 10us to 14us, not by attenuation.

d5: 25m ~ 50m; Length limitation between TEs by differential round trip delay of 2us.

Optional Cabling

Connect a 6 conductor mounting cord from the [G2-MSU](#) to a RJ-25 modular block.

Door Switch (Relay) Connection

- One Door Switch (24+-12VDC) may be used on the GDS-600 system.
- 2-conductor wiring is required.
- Connect the door switch to pins 1 and 6 of the RJ-11 connector.

Sensor Connection

- The Sensor connector on GDS-600 may be used for the External Sensor input.
- The sensor may be configured for normally open or normally closed operation.
- 2-conductor wiring is required.
- Connect the sensor to pins 2 and 5 of the RJ-11 connector.
- Refer to System Programming Form 39 -- Sensor Assignment.

Paging Connection

- The Paging connector on the GDS-600 may be used for an External Paging input.
- 2-conductor wiring is required.
- Connect the amplifier to pins 3 and 4 of the RJ-11 connector.

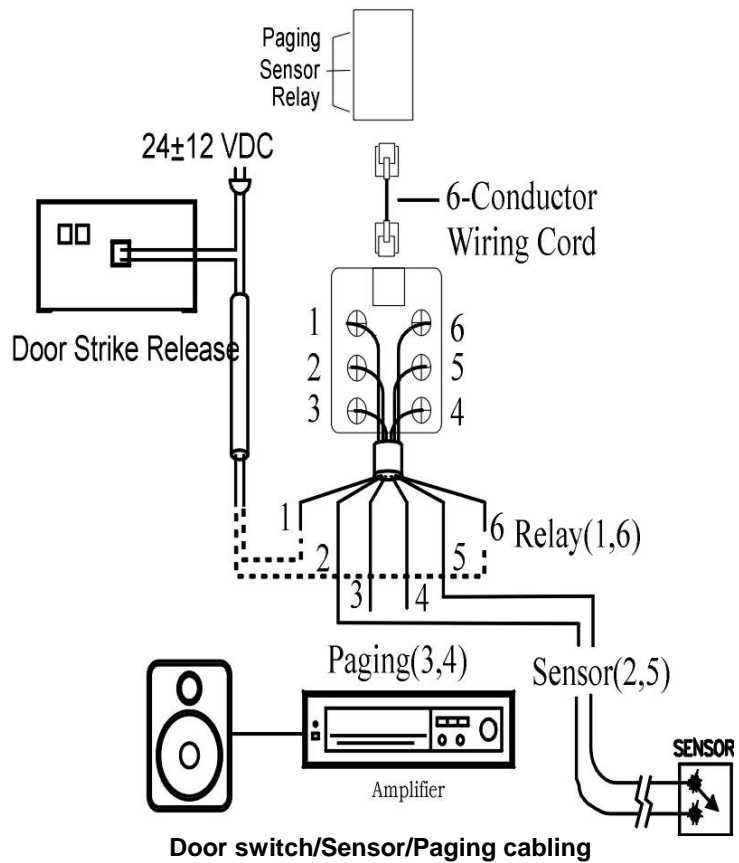

Refer to Illustration Door Switch / Sensor / Paging cabling:

Music on Hold Connection

- Connect the (optional) external music source to the external Music" input labeled on the KSU.
- Use a 1/8" mini plug to connect the music source to the KSU via an approved line isolation unit.

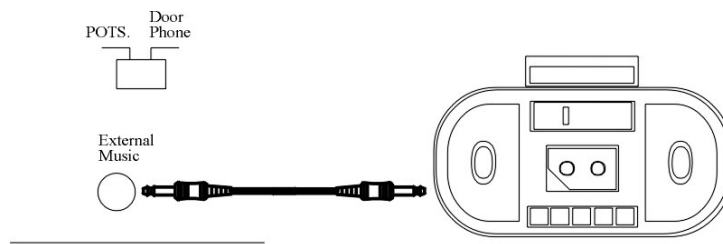

RS232 Port Connection

Use the RJ-11 connector to terminate the RS232 cable. Then connect the RJ-11 to the KSU with a 6 conductor line cord. Insert the line cord into the connector labeled RS-232.

Notice: Maximum recommended length of the RS232 cable is 15 metres.

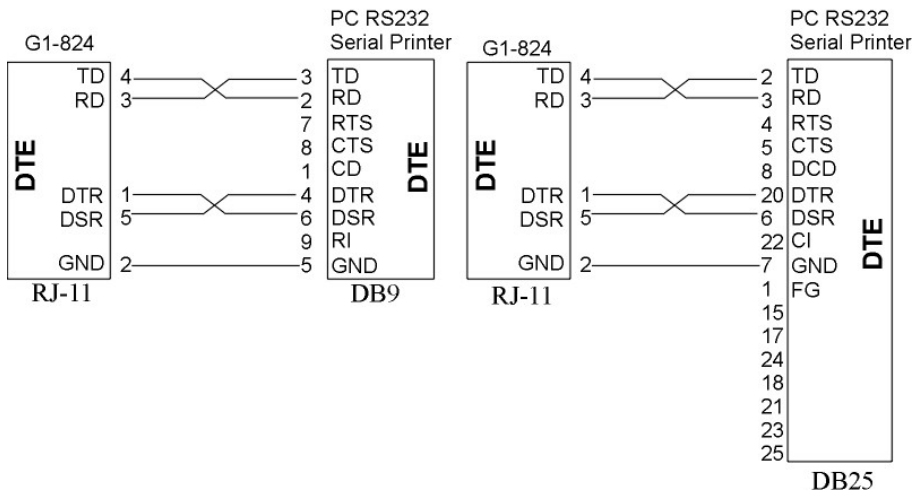
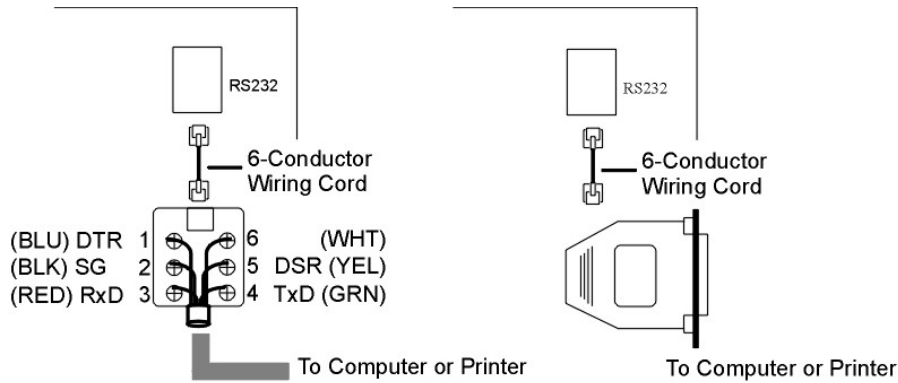

Power On and Operational Test

Before connecting the G2-PWU to AC power:

- Verify that input voltage and input voltage selection jumper on G2-PWU are correct before you power up the system.
- Recheck the cabling for incorrect connections, loose wires and wiring fragments that may cause short-circuits.
- Plug the power cord into a power outlet.
- Verify the system boots properly by checking the display of a telephone set.
- You may now connect the battery back up unit if applicable.

Operational Tests

Check each telephone and CO line to verify that outgoing lines are connected properly.
Check that intercom calls can be made from extension to extension.

WARNING:

DISCONNECT THE POWER SUPPLY FROM THE AC POWER SOURCE BEFORE WIRING OR CHANGING ANY WIRING.

Connect the Battery Backup *AFTER* AC power has been connected to the Power Supply.
Disconnect Battery Backup *BEFORE* disconnecting AC power from the Power Supply.

NOTICE:

ONCE THE SYSTEM OPERATES PROPERLY, PROCEED TO SYSTEM PROGRAMMING.
(REFER TO THE SYSTEM PROGRAMMING MANUAL.)

Special Immunity Protection for System and terminals

Adding a **Noise Filter** to the below points can enhance the immunity capability of the system to outside environment noise.

For Power Supply:



For Line:



GDS-600 Power Consumption Calculation for Emergency Battery Backup

Issue: V 1.1

For reference only

1. The unit power consumption of GDS 600

Item	Description	Average power consumption W(-40V)
1	GDS-64 main cabinet with G2-IPU and G2-MSU	3.02
2	GDS-160 main cabinet with G2-MPU2, G2-IPU and G2-MSU	4.49
3	GDS-320 main cabinet with G2-MPU4, G2-MXU4, G2-IPU, G2-IXU and G2-MSU	6.30
4	GDS-640 main cabinet with G2-MPU8, G2-MXU8, G2-IPU, G2-IXU and G2-MSU	6.30
5	G2-TKU	0.43
6	G1-CIC	0.55
7	G2-TKU2+G2-CIC2	1.80
8	G2-EMU	5.20
9	G2-IDU	4.80
10	G2-PIU	2.58
11	G2-VIU	2.94
12	G2-SIU	0.27
13	G2-STU	1.13
14	G2-STU2	2.30
15	G2-SLU	2.57
16	G2-HSU2/6	2.85
17	G2-HSU4/4	2.25
18	G2-VMU	0.54
19	Each digital key phone (Average)	1.25
20	Each single line phone (Average)	0.80

2. Battery discharge coefficient table for YUASA NP7-12 12V/7Ah x 4

Discharge coefficient CA	0.05	0.10	0.12	0.15	0.20	0.40	0.60	1.00	1.50
Discharge time(hours)	20	10	8	6	4	2	1	0.5 (30 min.)	0.33 (20 min.)

3. To calculate the running time of batteries

Example 1:**GDS-64 and 16 digital key phones (1 cabinet and 2 STU cards)**

- A. System power consumption:
 $GDS64 + G2-STU \times 2 + 16 \times \text{Digital phones} = 3.02 + (1.13 \times 2) + (16 \times 1.25) = 25.28w / 40v = 0.63A$
- B. b Discharge coefficient CA:
 $0.63 / (7Ah \times 0.5) = 0.18CA$
 (0.5= Estimated battery remnant capacity)
- C. Check above battery discharge coefficient table for 0.18 CA to get the discharge time of battery backup is around 4 hours.

Example 2:**GDS-160, 12 CO, 16 digital key phones and 40 single line phones
(1 80 port cabinet, 3 TKU cards, 2 STU cards, 5 SLU cards, 16 digital key phones and 40 SLTs)**

- A. System power consumption:
 $GDS 160 + G2-TKU \times 3 + G2-STU \times 2 + G2-SLU \times 5 + 16 \text{ digit phones} + 40 \text{ SLTs}$
 $= 4.49 + (0.43 \times 3) + (1.13 \times 2) + (2.57 \times 5) + (1.25 \times 16) + (0.8 \times 40) = 72.89w / 40v = 1.8A$
- B. Discharge coefficient CA:
 $1.8 / (7Ah \times 0.5) = 0.514 CA$
 (0.5= Estimated battery remnant capacity)

Check above coefficient table for 0.514 CA to get the discharge time of battery backup is around 1~1.5 hours.

GDS-600 UPS Battery Backup Time

Issue: V 1.0
For reference only

UPS Brand: Blazer
Models: Blazer 800 V.S. Blazer 1000

Model Compare Item	Blazer 800	Blazer 1000
Capacity	800VA/480W	1000VA/600W
Battery	12V/9AH x 1 pc	12V/7AH x 2 pcs
Output Waveform	Modified Waveform	Modified Waveform
Weight	6.5 kgs	13.8 kgs
Transfer Time	< 3ms	4-6 ms
Plug into AC Line	Power Switch on & then Battery can be charged .	Battery is charged when AC line is plugged in.
DC Fan	No	Yes
GDS 40 32 users (G1-PWU-2:40V/1.1A, 5V/1.1A)	Total: 43 mins, alert at 39 mins.	Total: 85 mins, alert at 77 mins. 87.8V/0.46A
GDS 64 48 users (G2-PWU-1: -40V/1.44A, 5V/3.22A)	Total: 33 mins, alert at 30 mins. 97.4V/0.68A, 103.8V/0.75A	Total: 61 mins, alert at 58 mins. 94.5V/0.65A, 104.5V/0.72A
GDS 80 80 users (G2-PWU-1: -40V/2.53A, 5V/3.8A)	Total: 19 mins, alert at 16 mins. 99.3Vac/1.11A	Total: 36 mins, alert at 33 mins. 97.6V/1.07A

Appendix A

Software Upgrade

G2-MPU2

1. The factory default TCP/IP address is 10.10.10.5
2. Use straight Ethernet cable to connect TCP/IP LAN port of MPU2 to LAN or use cross-over Ethernet cable to connect G2-MPU2 to a PC LAN card directly.
3. Program the TCP/IP environment on PC as below. (Below is the example for Windows XP Professional.)

A. Click [Start] -> [My Network Places]

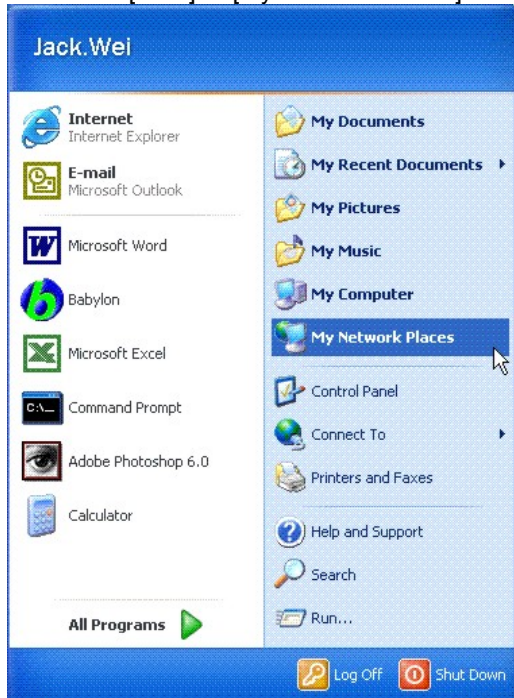

B. Click [View Network Connections]

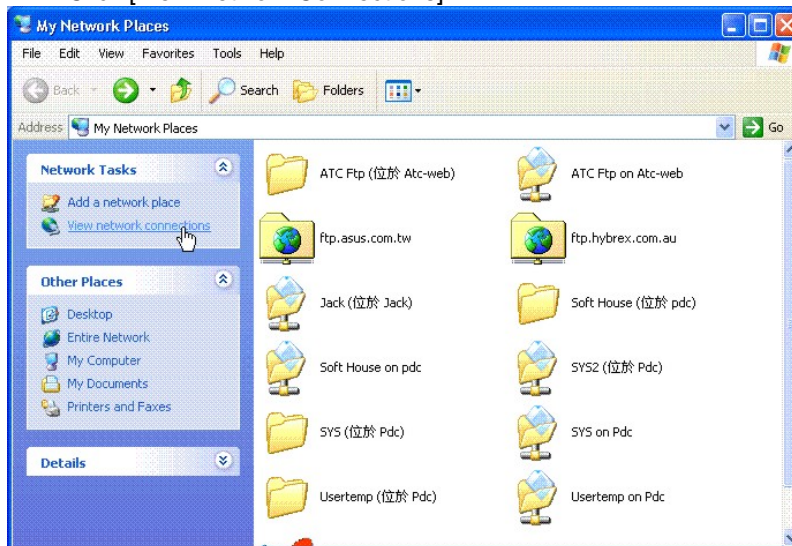

C. Use right button of mouse to click [LAN]. And then click [Properties].

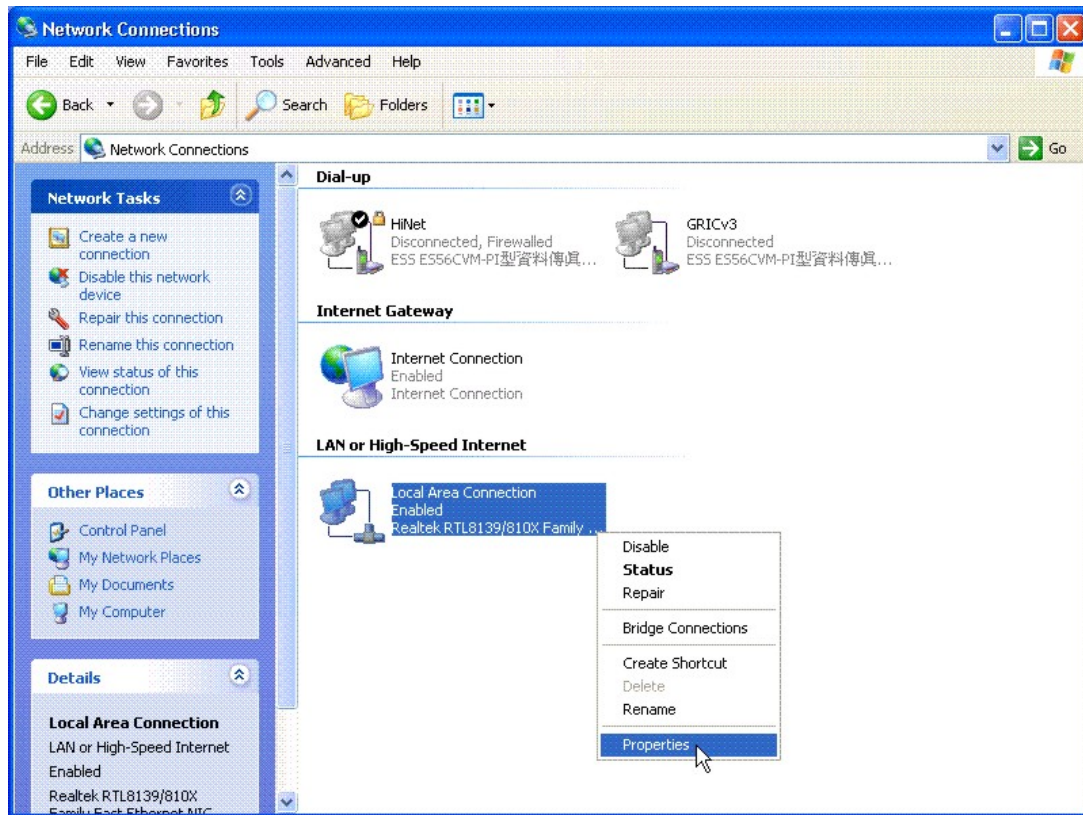

D. Click Internet Protocol (TCP/IP)

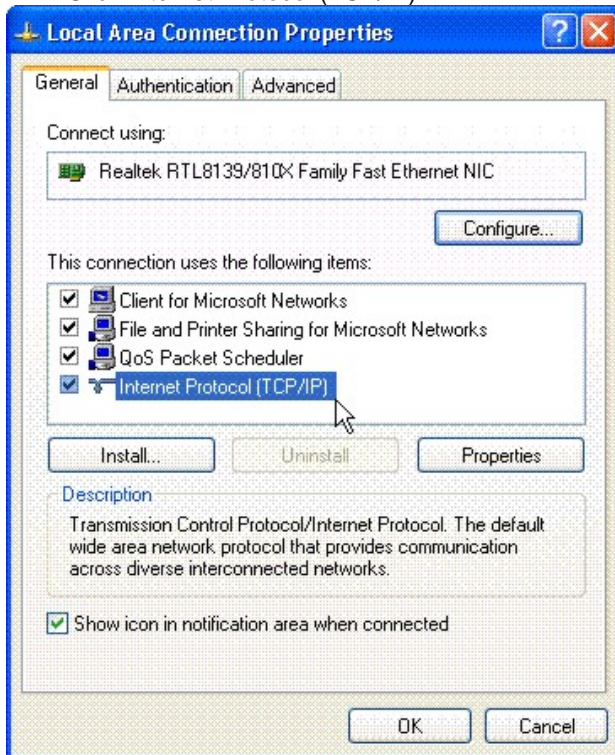

- E. Use the following IP address setting.
IP Address: 10.10.10.8
Subnet Mask: 255.255.255.0
Default gateway: 10.10.10.1

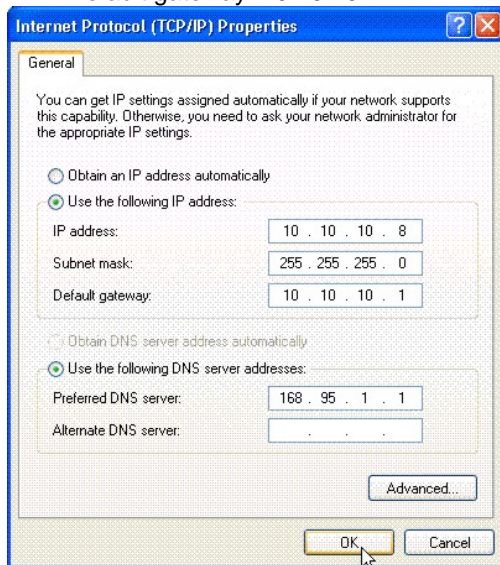

- F. Click [OK] to complete the setting. If necessary, restart the PC to let new IP work probably.
4. Use FTP program likes WS-FTP to connect to GDS600 FTP server.
- A. Name Profile Name
 - B. Configure Host Address to IP: 10.10.10.5
 - C. Configure Host Type: FTP TCP/IP 3.0
 - D. Type in user ID – “hybrex” and password “dyyyyyyd”

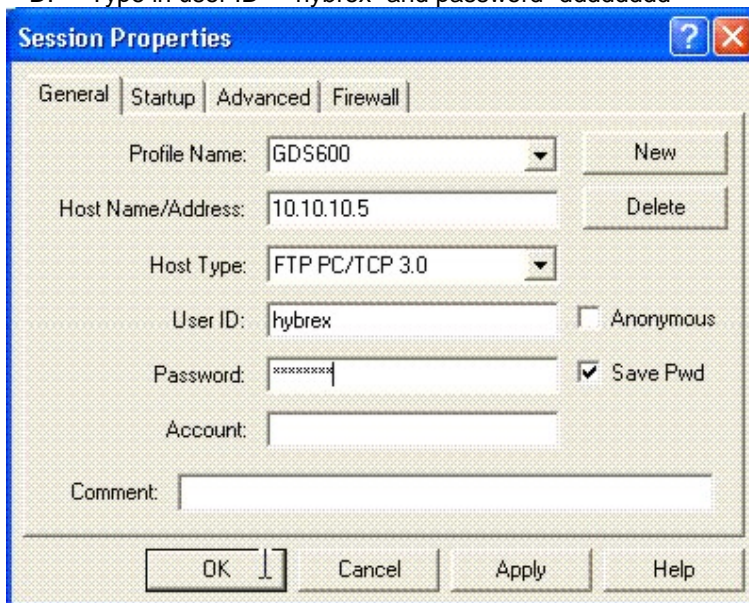

5. Configure FTP transfer not to use the "Passive transfer"

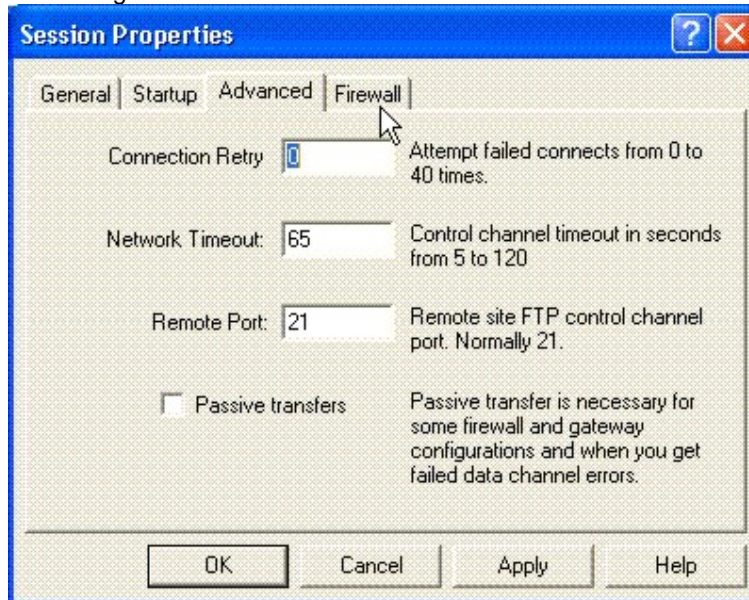

6. Click OK to make the connection and you will see the same information for the Remote Site as below.

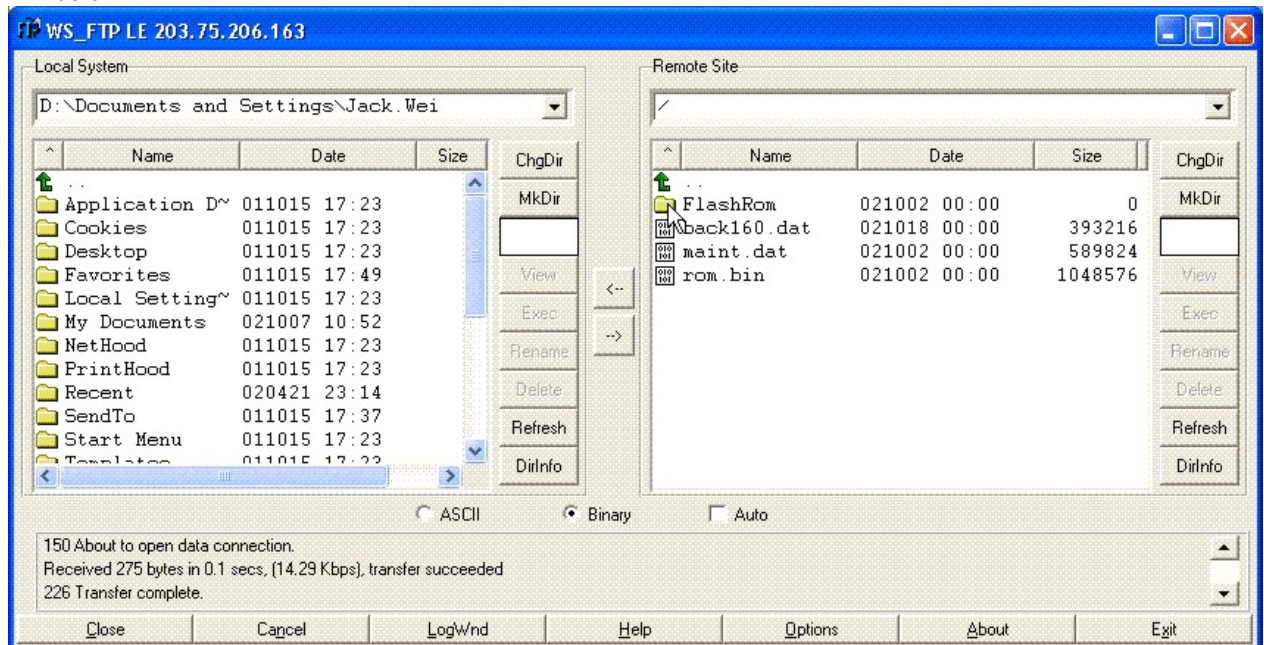

7. Click FlashRom folder and it will get the failed message as below. Click [Close] and [Connect] button again.

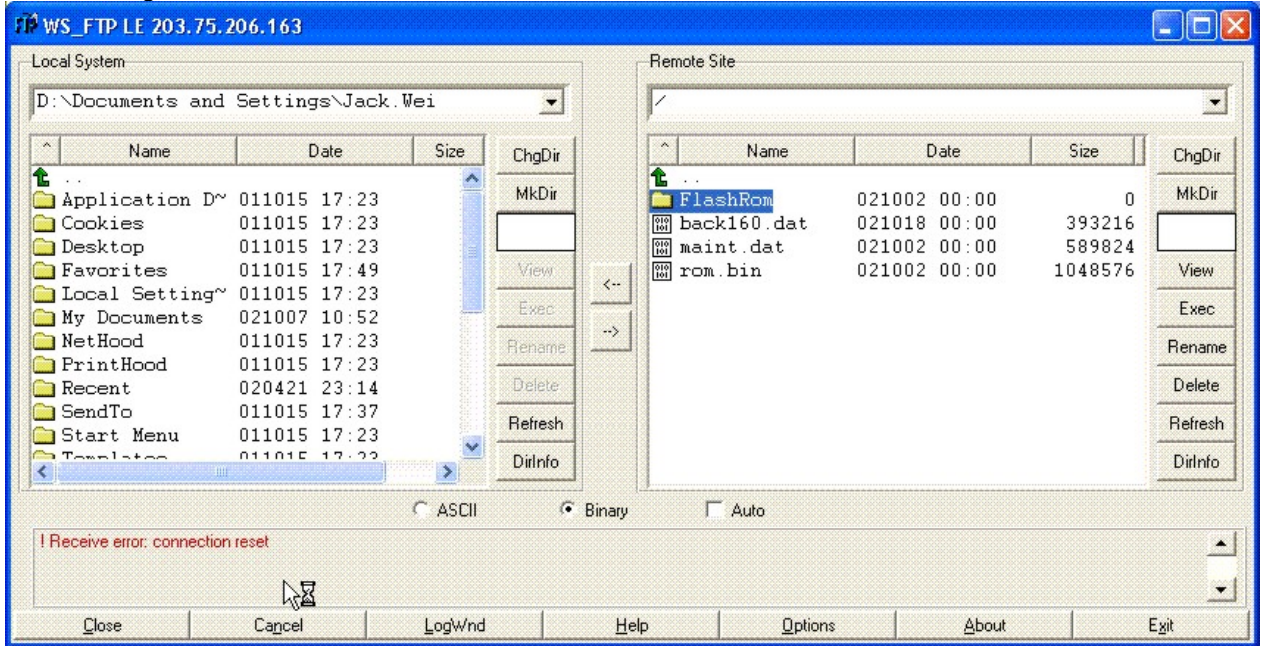

8. Login GDS 600 FTP server again and it will get the correct folder as below.

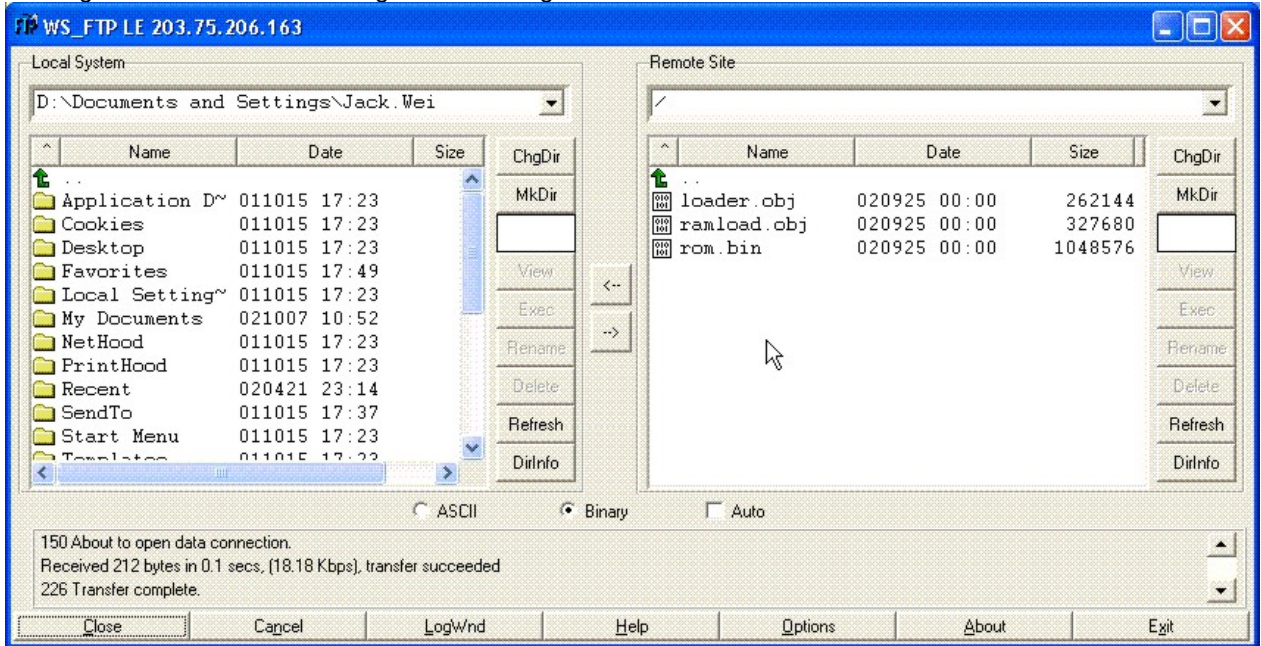

9. Click the folder in the local system for the upgrade software "rom.bin" of G2-MPU2.

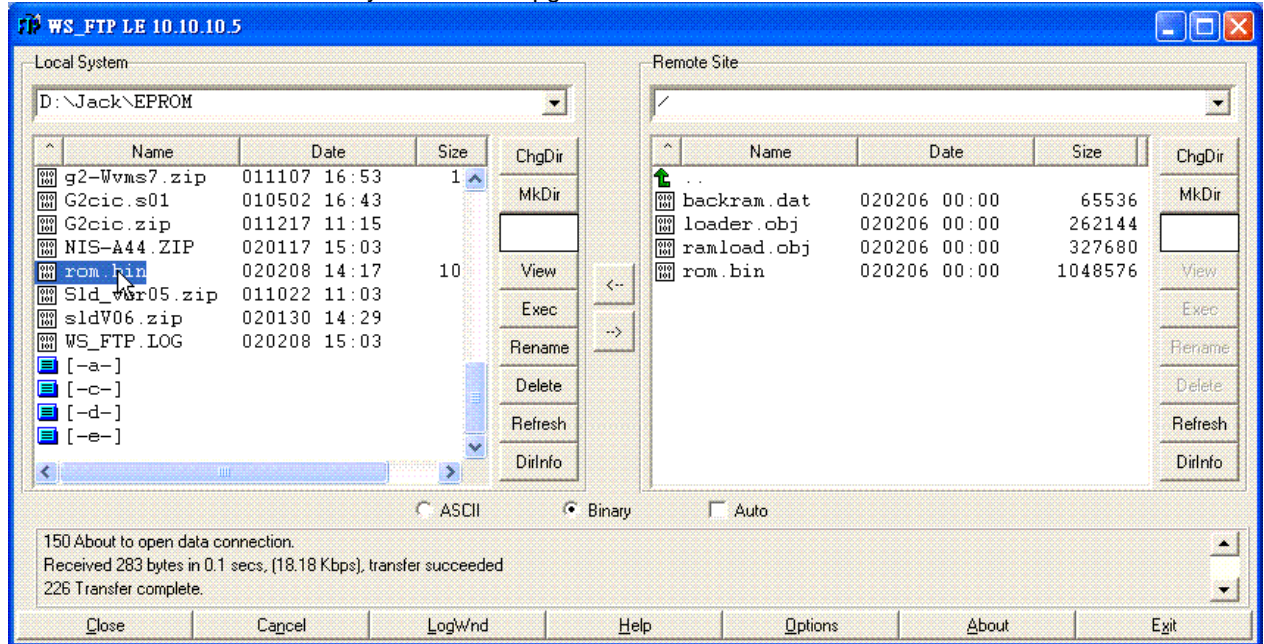

10. Select "rom.bin" and click -> to transfer the software to G2-MPU2.

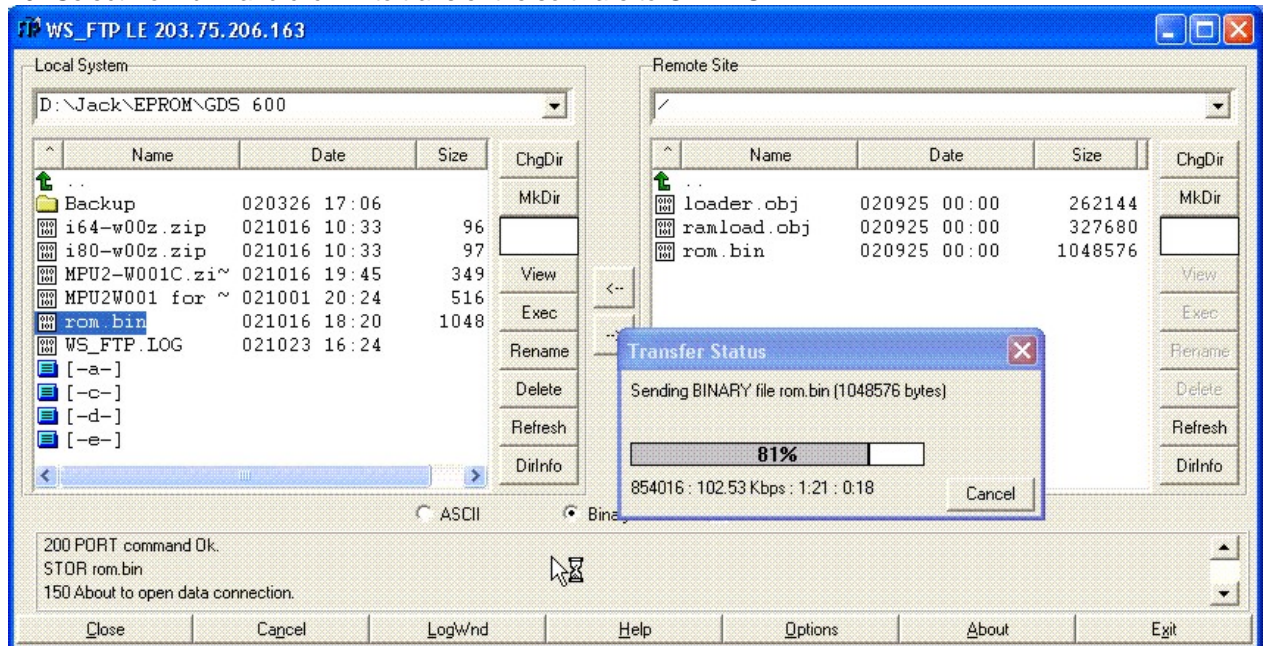

11. After the download is completed. System will restart automatically.



AUTO TELECOM COMPANY LIMITED

6F, 1, LANE 16, SEC. 2, SHIH CHUAN ROAD
PAN CHIAO CITY, TAIPEI, TAIWAN
<http://www.hybrex.com>

AUTO TELECOM (AUSTRALIA) PTY.LTD.

Unit 7, 3 Gibbes Street, Chatswood, NSW 2067

All data and specifications are subject to change without notice.



P/N: